

COMMScope®

Simplify and evolve your mobile network

A GUIDE FOR OPTIMIZING YOUR RF PATH



The background of the page features a silhouette of several communication towers of varying heights against a light blue sky. Overlaid on this are numerous curved, glowing lines in shades of blue and purple, representing radio frequency (RF) signal waves emanating from the towers. The overall aesthetic is technical and futuristic.

Contents

- Chapter 1** Introduction: Welcome to RF communications 3
- Chapter 2** The solutions, practices and trends: Cell site development 8
- Chapter 3** Getting the signal across: Base station antennas 18
- Chapter 4** Working within the limits: Co-siting solutions 43
- Chapter 5** Getting from the air to the network: Cables and connectivity 58
- Chapter 6** The impact of PIM on mobile networks 80
- Chapter 7** Spectrum management: Getting the most from every cycle 95
- Chapter 8** The infrastructure behind the call: Backhaul 104
- Chapter 9** The next RF architecture evolution: C-RAN 128
- Chapter 10** The energy of communications: Powering wireless networks 136
- Chapter 11** Successfully planning against failure: Reliability in wireless systems 158
- Chapter 12** Simplifying RF deployment where it matters 174

BIOGRAPHIES



Chapter 1

Introduction: Welcome to RF communications

With demand for 5G rising and 6G on the way, mobile operators need more of everything—more bandwidth and frequency support, more capacity and reach, more spectral efficiency and RF conditioning, more backhaul and power. That means adding more equipment, ports, bands and cabling to an already cluttered RF path. So how do you do it without adding more complexity? That's Challenge #1.

Challenge #2 is interoperability. The rate at which new technologies and applications are coming online is accelerating; the interval between disruptions is shrinking. To stay ahead, you need to constantly adapt your RF path to capitalize on the opportunities and mitigate the risks. It means making difficult decisions on how to modernize and restructure your sites and having the ability to integrate and deploy the best new technologies and architectures at the right time.

All the while, there's simmering pressure to add sustainability into your solutions and network, while deploying at the lowest CapEx and OpEx. Consider that Challenge #3.

Simplicity and innovation, agility and sustainability. These are the hallmarks of tomorrow's evolved RF path and a more powerful, prepared and profitable wireless network. We know because we've been involved from the beginning.



The CommScope Outdoor Wireless Network group

As technologies evolve, standards advance, and demand keeps growing, our commitment to delivering highly customizable, cutting-edge macro cellular and small cell network infrastructure guides our innovation and manufacturing as it has for over 85 years*.

Our expertise and technologies helped launch the first 2G, 3G and 4G networks; today, they enable 5G rollouts and will be a central component of 6G and the networks that follow. Each year, we invest significant dollars and resources to pioneer the solutions that enable you to meet your customers' growing expectations while simplifying your network.

As a global leader, we have our finger on the pulse of the industry and our eye on the horizon. We are also deeply attuned to our partners' business opportunities and challenges. We have the vision to see what's next and the resources needed to design and redesign solutions that ensure our customers are prepared.

At the same time, we recognize the potential environmental impacts of our efforts; therefore, we are committed to being part of the solution, not the problem.

All of this—our industry experience, design expertise, global perspective, customer collaborations and commitment to sustainability—provided the raw material used to create this ebook.



*Andrew® corporation founded in 1937—acquired by CommScope in 2007

About this ebook

The guidebook to RF path readiness is designed to help you plan a network infrastructure to support your immediate needs and long-term growth strategy. It is not intended to be a comprehensive discourse on every RF path component and condition. Think of it as a resource containing insights, ideas and solutions that we think are important when planning and designing a future-ready RF path. In addition to important technical information regarding the performance, evolution and optimization of your mobile network, you'll find current insights on the trends and issues affecting it.

So what can you expect to find in the following pages?

- Start by getting your bearings with an introduction to the RF path and an overview of cell site development solutions, trends and best practices. Then dive into the finer points of base station antennas, co-siting options and the importance of transmit/receive isolation for both.
- In chapters 5–8, we discuss cables and connectivity, provide insight on overcoming passive intermodulation (PIM), and help you get the most from your available spectrum and backhaul network.
- Chapters 9–12 are devoted to operational issues that are key to maximizing the reach and ROI of your outdoor network. These include developments in

C-RAN technologies, reliable power delivery and bringing outdoor wireless inside.

Where appropriate, we've included some of our more innovative and relevant solutions. If you're interested in learning more about them, great—we'd be happy to answer any question. Otherwise, use them as examples to understand how the industry is evolving and what's possible. We've also highlighted solutions and ideas that will be of special importance as climate change accelerates, as well as issues that have yet to be addressed.

"What's with all the green?"

Throughout this ebook, the theme of environmental stewardship is a common refrain. That is intentional. In its Smart 2020 report, the International Telecom Union estimates the ICT industry generates 2 percent of global greenhouse gas emissions and challenges the industry to reach net-zero by 2040. CommScope has a clear vision of our role in this effort and a roadmap to guide our journey. It features practical concrete steps that lead to a more sustainable network ecosystem and healthier planet. For example:

- Improve radio planning to right-size network capacity
- Use more energy-efficient antennas
- Seek out eco-friendly network equipment
- Consider greener power and cooling solutions
- Select supply chain partners who are committed to being part of the solution.

Please consider the "green content" in this book with the same gravity as the situation facing our world.



Chapter by chapter, we're redefining the RF path

Thanks for spending some time exploring The guidebook to RF path readiness. At more than 200 pages, there's a lot of information here. Please don't feel you have to read it cover to cover in one sitting. Find a chapter that interests you, take a few minutes to digest it, then spend a few days considering the ideas presented. Our hope is that each chapter will provide a new thought, spark a new question or lead to a breakthrough that helps you do your job better.

When you're ready to start planning your next network deployment or upgrade, we hope you'll give us a call. Let us show you what's possible when you simplify and innovate everywhere it matters.



Contact and Support

<https://www.commscope.com/contact-us>



Chapter 2

The solutions, practices and trends: Cell site development

Building a new cell site—or upgrading an existing one—raises some of the same questions as building a new house. You have to decide what materials to use, who to entrust with the construction, estimating the environmental impact and how to get the best results for your money.

Building or retrofitting a site also forces a discussion about the latest technologies, practices and solutions. The components you use for a site today may be very different from those used for a site built a year ago—and best practices may have evolved as well. In this chapter, we'll look at some of these solutions and practices as they exist today and try to discern which trends, current and future, are worth noting.

Chances are that, if you are developing a new cell site or upgrading an existing site, you will have plenty of third-party help in the process; site deployments involve many different RF disciplines. The topics we'll cover here will span the appropriate scale of the deployment, your contractors' work and the decisions you will have to make with them.

Macro or metro? Know the difference.

First and foremost, you need to know how the site, along with its scope and scale, fits into your overall wireless strategy. The two primary choices are macro cell sites and metro cell sites.

Macro sites are the large steel towers you're familiar with. They typically host many different antennas, as well as the cabling and radio equipment needed to receive and transmit cellular signals over a wide area. Metro cells, on the other hand, are smaller, more easily concealed sites designed to meet stringent appearance and size criteria demanded by many urban zoning regulations.

While metro cells are an important part of a forward-thinking wireless strategy, this book will mainly address the processes and components involved in deployments of macro cell sites. We will begin with the cabling infrastructure.

Choosing cable and connectors

Efficient cell site operation relies on the precise pairing of components. Some of those components, known as passive components, do not need electrical power as their job is to handle the RF signals that carry the site's cellular traffic. Other components are active, meaning they require both power and an RF signal to perform their specific task. As a result, the cabling that connects the various components must be designed to conduct RF signals only or power plus RF signals.

Macro cell sites

Large, conventional, standalone cell sites that occupy a dedicated space.

Metro cell sites

Smaller, lower-power cell sites that can be concealed in lamp posts or other fixtures to add network capacity with fewer zoning and aesthetic challenges.

Historically, copper coaxial cables (Figure 2.1) have been the de facto choice for carrying RF-only signals, specifically between the radio and antenna. To conduct both RF and power signals, mobile networks most often use a hybrid cable that combines fiber-optic strands and a power conductor in a single cable (Figure 2.2). These are used to transmit data and power from the base station on the ground to the radios on the tower. With more and more sites moving to fiber-optic connections between radios and base station, most new installations use hybrid rather than coaxial cable.

It should also be noted that a hybrid cable uses less material and is lighter in weight than separate fiber

and power cables. This more efficient design also provides key advantages regarding the environmental impact created during manufacturing, packaging and distribution.

As we will discuss in detail in Chapter 3, certain cable types are designed to work with certain antennas. In Chapter 7, we'll explore modern connectivity solutions including how connectors built for certain frequencies and power levels are used to best match the components they connect.

Coaxial cable

A copper cable featuring an inner conductive core, outer conductive layer and a dielectric (insulating space) between them. Coaxial cable “jumpers” connect antennas to radios.

Hybrid cable

A cable combining both fiber-optic strands and a copper power conductor. Hybrid cables are used to remotely power tower-mounted radios and connect them to base stations located on the ground.



2.1: Coaxial cables showing the inner conductor and shielding layer separated by dielectric insulator

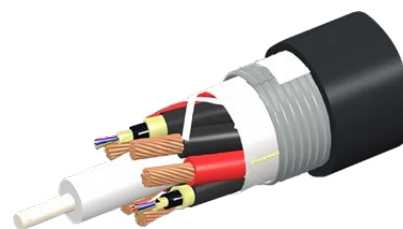

2.2: Hybrid cable containing fiber-optic and copper power cables

Best practices for cable handling

During installation, both coaxial and hybrid cable must be handled carefully to avoid damaging their internal structure and seriously compromising their RF performance. Here are several best practices for installations:

- **Use the right tool for the job.** Use the appropriate cable prep tool—usually available from the cable’s manufacturer—to cut and prep cable ends. Never use a saw, as it leaves metal filings behind that cause poor electrical performance and problems with passive intermodulation (PIM).
- **Watch those tricky curves.** Different cable types have different degrees of allowable bend radii, or flexibility. You must observe the manufacturer’s prescribed bend radius for your particular cable to ensure its specified performance. Bending too tightly can lead to poor electrical performance in coaxial cable; overbending the glass in a fiber-optic cable can cause stress cracks that may also cripple performance.
- **Keep your cables consistent.** When possible, use RF jumper cables (coaxial or hybrid) from the same manufacturer to ensure tight connections. Doing so provides consistent RF performance and guarantees PIM performance.
- **Ensure proper cable support.** Manufacturers publish specifications describing how to support lengths of cable, both vertically and horizontally. Your specific guidelines will depend on your cable’s

construction, size and weight. If possible, use support clamps from the same manufacturer to avoid damaging the cable and loss of performance. Using third-party clamps may also invalidate your warranty.

- **Use the right hoisting grips.** Hoisting cables up a cell tower is difficult. Using the correct hoisting grip helps lift the cable into position without damaging it. Hoisting grips come in several types and sizes; ensure yours matches your cable’s specifications.
- **Proper cable grounding.** Grounding the cable is very important to prevent damage from lightning strikes. Best practices dictate at least three grounding points: at the top of the tower, bottom of the tower, and just outside the entrance to the outbuilding, shelter or cabinet.
- **Weatherproofing connections.** Connectors are particularly vulnerable to the infiltration of moisture. As soon as the connections are made, you should weatherproof them. Butyl tape is the preferred method but, in tight spaces, like those atop the antenna tower, you can opt for heat-shrink tubing applied with a heat gun.

By following these recommendations, you can help ensure the cabling used in your cell site will operate at peak efficiency with minimal maintenance. Reduced maintenance means fewer truck rolls, which lowers your CO₂ emissions and your overall carbon footprint.



Mounts matter

More and more components in the RF path are being mounted on towers; these include remote radios, amplifiers and additional antennas to support newly acquired spectrum. Using the correct mounting hardware for these components is vital to ensure proper support and trouble-free operation. Overloaded tower tops with insufficient mounting solutions can shorten the operational life of equipment and introduce the possibility of performance-sapping PIM (see Chapter 6).

The mounts for a six-foot-diameter microwave antenna must be rated to withstand 1,400 pounds of lateral force to ensure it remains on target even in high winds. You can learn more about the functioning of microwave backhaul systems in Chapter 8.

Using the right mount is particularly important for larger antennas like microwave backhaul antennas and parabolic antennas. These antennas can be very heavy, and their large surface area can act as a sail, catching a great deal of wind. This not only increases the overall wind load on the tower, but it can also physically move (deflect) the antenna, altering its beam alignment. A 0.1-inch deflection over several miles can cause the antenna to completely miss the receiver on the other end.

One of the most effective ways to improve antenna performance is beamtilt. Physically tilting the antenna's orientation below the horizon concentrates the gain—its operational power—where it's needed most. We dive deeper into this concept in Chapter 3.

Using remote electrical tilt antennas

Remote electrical tilt (a.k.a. RET) involves a motorized antenna actuator that alters the electrical downtilt by adjusting the phase shifter. The actuators can be operated from a remote location (Figures 2.3 and 2.4), reducing the need for truck rolls. The process is controlled by an Antenna Interface Standards Group (AISG) RET controller, which connects to the antenna via AISG cables. Alternatively, if the antenna is equipped with smart bias tees (SBT), the AISG signal can be carried to the antenna via coaxial cable that connects to the actuator inside the antenna. When using this configuration, the coaxial cable carrying the AISG signal must be connected to an SBT-equipped port.

RET-enabled antennas require a high degree of precision; therefore, properly installing and adjusting them can be a challenge. Getting the best result is a matter of understanding the software as well as the hardware.

Electrical tilt antenna

An antenna fitted with actuators that can adjust its tilt relative to the ground. Changing tilt affects gain, or performance, of the antenna within defined geographical areas.

Here are several ways to avoid common pitfalls:

- **Install the software first.** Before your crew goes to the cell site, install the manufacturer's software and become familiar with the controller's operation. This early training will help your team hit the ground running.
- **Check for program updates.** Just like your laptop or cell phone, your RET system uses driver software, which must be updated. These updates improve operation and expand compatibility to include more types of antennas. Make sure your software is current by checking for updates on the manufacturer's website.
- **Understand the naming conventions.** To prevent onsite confusion, use conventions for the configuration of actuators that everyone will understand.
- **Test before installing.** For new installations, test the actuators, cables and other components before installing them on the tower. It's much easier to address problems when the components, and you, are on the ground.
- **Match antennas and tilts.** Not every antenna has the same tilt range, so be sure you select the correct one from the database before adjusting it. Each antenna's address is based on its product serial number, so be sure to keep a written record. You should double-check your tilts through tab reports generated by the controller.



2.3: A base station antenna (BSA) with integrated RET actuators



2.4: ATC-200 LITE

- **Keep a spare cable on hand.** Bring a spare cable to the site in case you need to troubleshoot a non-reporting actuator. It's the fastest, surest way to tell if the problem is a faulty actuator or just a bad cable.
 - **Check before tilting.** Before making any new tilt adjustments, pre-scan the other antennas to determine their tilt values.
 - **Double-check your work.** After making the adjustment, perform a post-scan to confirm the new settings have been correctly applied.
 - **Don't tape cables and connectors.** Using electrical tape won't keep moisture out—in fact, it gives water a place to accumulate in the connector, where it can cause shorts.
 - **Protect against lightning.** Install lightning protection units at the base of the tower, or just before the cable enters the shelter or cabinet. Also, as stated above, it should be grounded in at least three locations: at the top of the tower, at the bottom of the tower, and just before entering the enclosure or platform.
 - **Don't splice in a ground lead.** Cutting into the jacket to attach a ground to the thin foil tape inside will cause water migration, damaging the conductors below the foil.
 - **Go right to the source for cable.** It's considered good practice to purchase your cable directly from the manufacturer rather than obtaining it through a third party. Each manufacturer's system requires specific electrical conductors; using a mismatched cable may lead to actuator failure, voiding your warranty.
 - **Make the right connections.** The home run cable's male connector—the end with the pins—is the end that connects to the controller. Also, be careful not to cross-thread actuator cables at the controller or on the actuator itself. They should be hand tightened only. Never use a wrench.
 - **Cycle the actuators when you're done.** After addressing each actuator, cycle it fully to confirm there are no hidden problems.
 - **Check for cable stress.** All cables should be free of stress and secured in intervals of 18 to 24 inches, or per manufacturer's standards. Keep in mind that coaxial and hybrid cable have different handling and hanging instructions.
- Thorough planning and clear procedures like these will ensure your cell site reaches and maintains its maximum potential while also allowing you to make the proper adjustments as your network evolves.

The bottom of the tower is evolving as well

New connectivity options aren't the only recent advances in cell site design. The base station and associated equipment at the bottom of the tower are also trending toward more energy-efficient designs and strategies. As the network's carbon footprint and the operator's environmental impact come under closer scrutiny, these newer designs offer significant advantages.

Traditional enclosures—the small buildings you see at the base of some cell towers—are becoming a thing of the past. Those still being used (Figure 2.5) range in size from a medium-sized shed to a modest-sized home depending on the amount of equipment they support.

Inside the enclosure, cabling from the tower terminates at the baseband unit. Other components in the enclosure may include electrical transformers, large battery power backup arrays, racks of switches and servers, connectivity to the core network, and the climate control equipment needed to keep the equipment operating within its specified temperatures. Much of this equipment requires a significant amount of power and generates a lot of heat that must be constantly removed from the enclosure.

As cell sites have become more powerful and numerous, it has become clear this traditional way of storing and operating the base station equipment is relatively



2.5: A traditional cell site enclosure housing radio and base station components

inefficient, its energy demand is unsustainably steep and its complexity slows new site installations just as operators need to roll out more new deployments than ever. Therefore, conventional enclosures are being replaced by new, more efficient and sustainable solutions such as platforms, freestanding cabinets and enclosures with free-air cooling.

Platforms and cabinets

Platform-built base stations (Figure 2.7) eliminate the need for enclosures altogether. With a lower cost, faster deployment and greater energy efficiency, they are a rapidly growing trend. Given that the trend toward integrated electronics has resulted in increased heat output in a more compact footprint, the open-air design makes platforms especially attractive. By enabling air cooling, platforms can better manage heat removal to reduce energy use and operating costs.

A platform solution typically features integrated electrical grounding, fiber and copper connectivity support, and enough room for the base station equipment—plus a little extra for a technician to service the components located in the cabinets on the platform. It's surprising how much performance can be loaded onto such a platform, which is, in all ways, a miniaturized cell site base station without the building—and without the extra costs and weeks of construction time a traditional enclosure requires.

A typical CommScope platform solution like the one pictured in Figure 2.6 includes:

- Fiber cable and cable entry kits
- Grounding lugs and bars
- Battery backup cabinets
- BBU, RF and fiber equipment cabinets
- Canopies and ice shields
- H-frames for mounting ancillary enclosures
- Railings, platform and footing supports
- Seismic bracing



2.6: An example of a CommScope platform solution that replaces a traditional cell site enclosure

Free-air cooling enclosures

Free-air cooling (Figure 2.7) is another fast-growing practice making its way to the bottom of the tower. Free-air cooling uses advanced backward-curved radial fans to force outside air through the enclosure. The air is directed downward, forcing the warmer interior air up and out of exhaust vents located on the opposite side of the enclosure. To prevent airborne contaminants from affecting the sensitive electronics inside, free-air solutions incorporate sophisticated filtration systems.

This solution is designed for sites where use of a platform is not feasible, such as a new site with complex equipment configurations. Free-air cooling can also be used to retrofit an existing enclosure to make it more efficient. For example, CommScope’s Monitor solution (Figure 2.8) reduces the internal temperature inside the enclosure by 10 degrees Celsius without the use of any air conditioning.

As more and more industries gain insights into their electrical costs—in environmental as well as financial terms—there’s a great deal of impetus to reduce the impact of air conditioning on the balance sheet and on the CO₂ footprint.

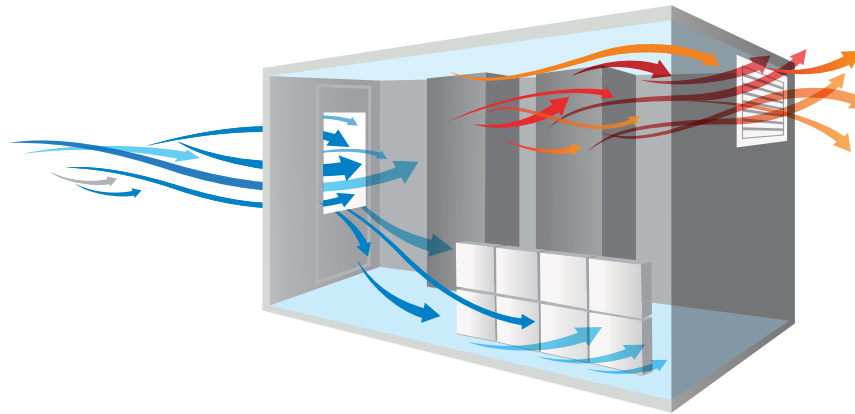

2.7: Free-air cooling system



2.8: The inlet and filtration system on CommScope’s Monitor free-air cooling solution

Chapter 2 summary

Cell site development

- Technologies are evolving fast
- Coaxial and hybrid cable solutions have distinct handling requirements and installation practices
- Fiber-based solutions are becoming the norm
- Remote electrical tilt can improve site performance
- Traditional enclosures are being replaced with more compact and efficient platform solutions
- Free-air cooling helps improve the energy efficiency of sites where enclosures are still required
- Consistency in manufacturer can help simplify site deployments



Chapter 3

Getting the signal across: Base station antennas

The quest for a stronger mobile signal—or, in some places, any signal—has become a routine part of our daily lives. Having more service bars means a stronger connection and better reception, and that depends on antennas. For wireless operators, antennas are the vehicles that power network expansion, allowing operators to better serve larger areas, more densely-populated regions, additional spectrum and other avenues of network growth.

The antenna is one of the most critical parts of both the transmit and receive paths, and often the most visible part. Antennas come in all shapes and sizes because each is built for a specific purpose. However, all antennas share a common link: They are the key to how well—and how far—communications can be shared.

CommScope has been a trusted partner to all kinds of wireless networks worldwide for decades, owing to our deep expertise in antenna design and investment in cutting-edge antenna innovation.

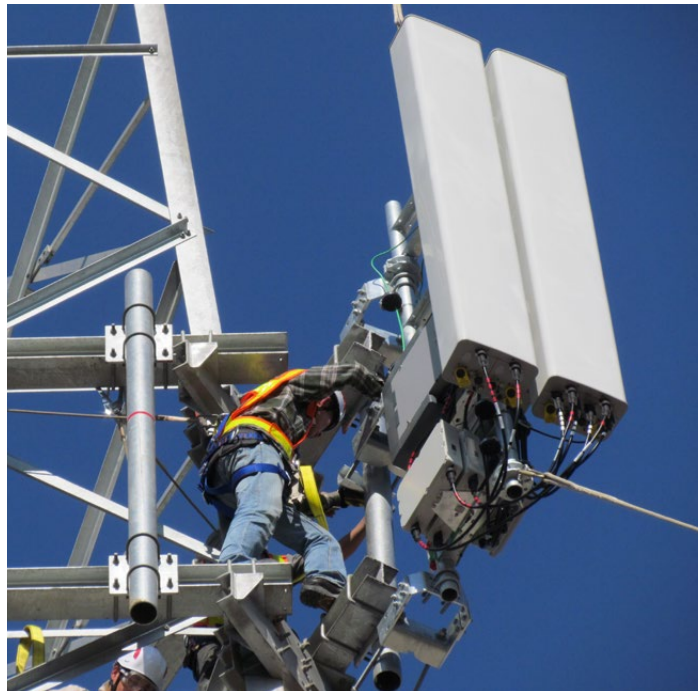

The emergence of base station antenna standards (BASTA)

In 2014, the Next Generation Mobile Networks Alliance (NGMA) published the base station antenna standards (BASTA) for LTE networks. BASTA defines a unified approach to procurement and long-term network planning, and provides common measurements of network performance across the industry. They make it easier and more economical for operators to expand their LTE networks.

In early 2022, NGNM's BASTA passive antenna committee released updated standards for that include beamforming antennas. There is also a separate committee for active antennas that sets standards for M-MIMO antennas.

What is an antenna?

At its most basic level, an antenna is the portion of a radio system that:

1. Radiates radio energy from a transmission line in a predictable pattern, and
2. Receives radio energy from open space and feed it back down a transmission line.

Antennas are surprisingly efficient in transferring radio energy from line-to-space and space-to-line. When properly configured with the right components, antennas can yield 80% efficiency or greater. Compare this to the common incandescent light bulb, which converts only 20% of the total input energy to visible light. A key to maintaining an antenna's extraordinary efficiency is the transmission cable that connects it to the transmitter.

Matching the line

To get maximum efficiency from a radio transmission's power, the antenna and cable must share certain characteristics to avoid wasted energy. For example, if a radio system uses an industry standard coaxial cable fixed at 50 ohms to connect the antenna and its transmitter, the antenna itself must rate reasonably close to 50 ohms as well.

Testing this configuration is a simple task. We connect coaxial cable to the transmitter and place a 50-ohm "dummy load" on the other end to simulate an antenna. Using a watt meter reveals two important factors that enable us to measure the system's efficiency:

1. The amount of power entering the cable from the transmitter, and
2. The amount of power reaching the dummy load.

The difference between these two measurements represents the power lost in the line itself. The better matched the cable, the smaller the difference—and the more power reaches our simulated antenna.

If we reduce the antenna's load from 50 ohms to 25 ohms, 11 percent of the energy sent through the coaxial cable is reflected back to the transmitter, lowering the efficiency. To restore the balance, we'd need to replace the 50-ohm coaxial cable with one rated at about 25 ohms. Even then, we'd only be moving the reflection point where the cable connects to the transmitter.

Antenna:

The portion of an RF system that radiates radio energy into space and collects it from space.

Dummy load:

A simulated power load applied to an electrical system for testing purposes.

In a radio system, mismatched impedance causes energy to reflect back and forth between the transmitter and antenna. This endlessly reflected power creates a measurable wave pattern in the cable—an effect called the “voltage standing wave ratio” (VSWR).

Expressed as a ratio, VSWR is the measurement of how well matched a transmission line is to its antenna. A VSWR of 1.0:1 indicates a perfect match. Likewise, a VSWR of 1.5:1 indicates a 4% power reflection, which is another way of describing 96% efficiency, where 96% of the power output from the transmitter actually makes it to the antenna (Table 3.1).

Hidden cost of an unbalanced transmission line

Mismatched impedance in a cell site’s transmission lines not only creates inefficiencies in the RF path; there are environmental implications that are becoming hard for network operators to ignore. The greater the impedance in a transmission system, the more power is needed to maintain the proper gain. Today’s mobile operators are under increasing pressure to reduce their carbon footprint while expanding their network coverage and capacity.



Voltage standing wave ratio (VSWR)

A measurement of the power reflected between transmitter and antenna in a transmission line that connects the two. This figure yields the system’s transmission efficiency.

Calculating voltage standing wave ratio (VSWR)

VSWR	Return loss (dB)	Reflected power (%)	Through power (%)
1.10	26.5	0.2	99.8
1.25	19.1	1.2	98.8
1.50	14.1	4.0	96.0
1.75	11.6	7.4	92.6
2.00	10.0	11.0	89.0

$$VSWR = [1 + 10^{((-Return Loss)/20)}] / [1 - 10^{((-Return Loss)/20)}]$$

3.1: Calculating VSWR, and some sample efficiencies

Velocity, frequency and wavelength

Like all forms of radiation, including visible light, radio waves travel about 186,000 miles—almost a billion feet (30 billion cm)—per second. These waves oscillate, flip back and forth, between plus and minus at a predictable rate. Each complete flip is called a “cycle,” expressed in hertz (Figure 3.2). Measuring how many cycles, or hertz, a signal oscillates per second gives us its frequency—literally, how “frequently” the signal oscillates in one second.

Knowing a signal’s speed and its frequency, we can divide the first by the second to determine its wavelength—the distance the signal travels

while completing one full cycle. Wavelengths are usually measured in feet or inches and are useful in understanding what it means to be “in phase” or “out of phase,” which we’ll explore later in this chapter.

Antennas are two-way streets

In theory, antennas transmit and receive in precisely the same way—only the direction is reversed. In practice, however, complicating factors, particularly on the receiving end, can impact the efficiency with which the antenna operates.

To demonstrate, it is perhaps easiest to explore the most basic of antennas: the half-wave dipole.

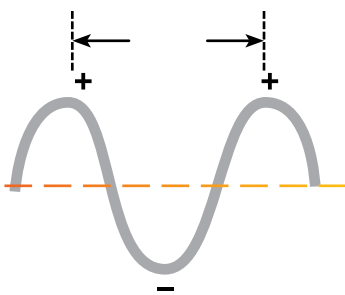

A cycle completes itself traveling from plus to minus back to plus.

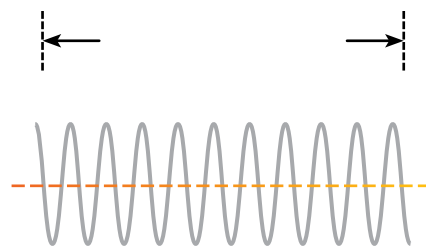

The number of cycles in one second gives the frequency.

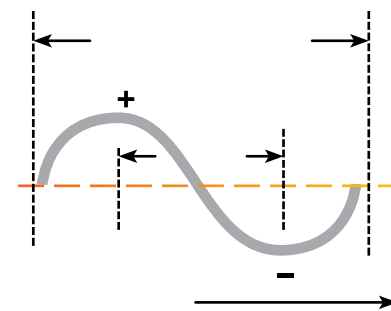

The speed divided by the frequency gives the distance the wave travels in one cycle. This is called the wavelength.

3.2: Relationship of time, frequency, and wavelength

Half-wave dipole

The half-wave dipole radiator antenna, often just called a “dipole,” is the most basic antenna used in two-way base station applications. It is essentially a straight conductor made of wire, rod or tubing that measures exactly half of its assigned frequency’s wavelength. A rule of thumb for determining wavelength at a given frequency is:

$$\text{Length (in centimeters)} = 30 \text{ divided by the desired frequency in GHz}$$

As a result, dipole antenna length can be highly variable. It could be just 0.5 cm in length for a frequency of 28 GHz, or 21 cm long for a frequency of 700 MHz. Table 3.3 provides more examples.

Generally, the feeder line is connected at the midpoint, so the antenna radiates at maximum intensity in the middle of the dipole (Figure 3.4).

Frequency (MHz)	1/2 Wavelength (inches)	1/2 Wavelength (centimeters)	Frequency (MHz)	1/2 Wavelength (inches)	1/2 Wavelength (centimeters)
30	196.8	499.9	800	7.4	18.8
50	118.1	300.0	900	6.6	16.8
74	79.8	202.7	1700	3.5	8.9
150	39.4	100.1	1900	3.1	7.9
220	26.8	68.1	2100	2.8	7.1
450	13.1	33.3	2500	2.4	6.1
750	7.9	20.1	3500	1.7	4.3

3.3: Half wavelengths of two-way frequencies

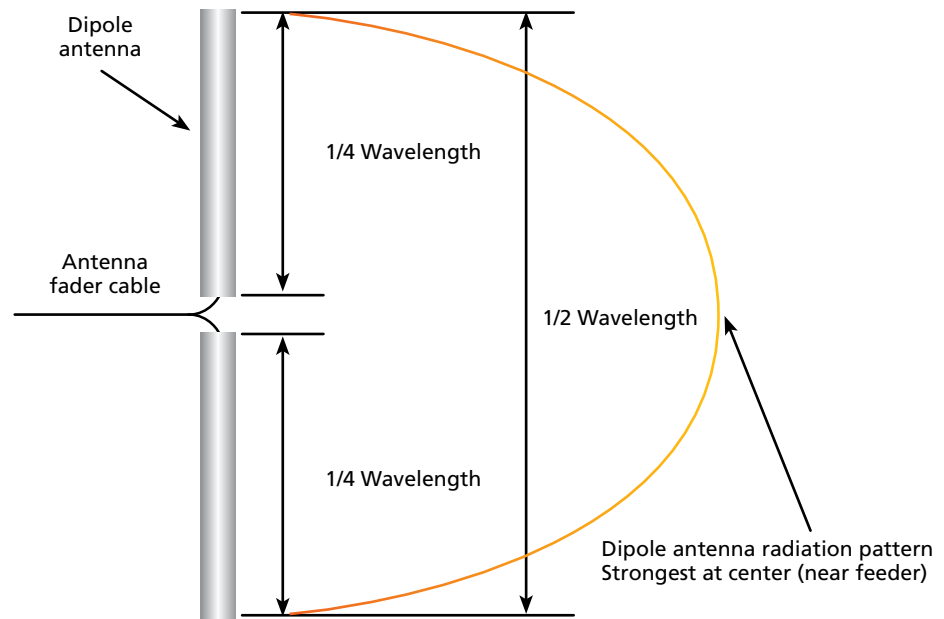

3.4: Dipole antenna construction and radiation pattern

Vertical and horizontal antenna radiation patterns

All antennas, regardless of polarization, have three-dimensional radiation patterns. If the pattern is extended in all directions equally, the resulting shape would be a sphere with the antenna at its center. The polarization of the antenna determines which portion of that sphere represents an antenna's actual pattern. Slicing the sphere vertically yields a vertical circle, while a horizontal slice would reveal a horizontal circle.

Both polarization patterns (horizontal circle and vertical circle) appear to be omnidirectional within their planes, but that's not quite the case. In practice, there are no truly omnidirectional antennas. The pattern of our sample half-wave dipole antenna (Figure 3.5), for instance, reveals the truth. It appears circular, like a doughnut, on a horizontal plane, but forms a figure-8 in the vertical plane.

As we will see later in this section, most real-world antennas consist of a vertical array of radiating elements—and elevation pattern shaping has become quite important for interference minimization.

Antenna gain

As shown in Figure 3.5, the level of radiated power density varies in space depending on the position relative to the antenna. The ability of an antenna to focus energy in a specific direction is described by its directivity and gain.

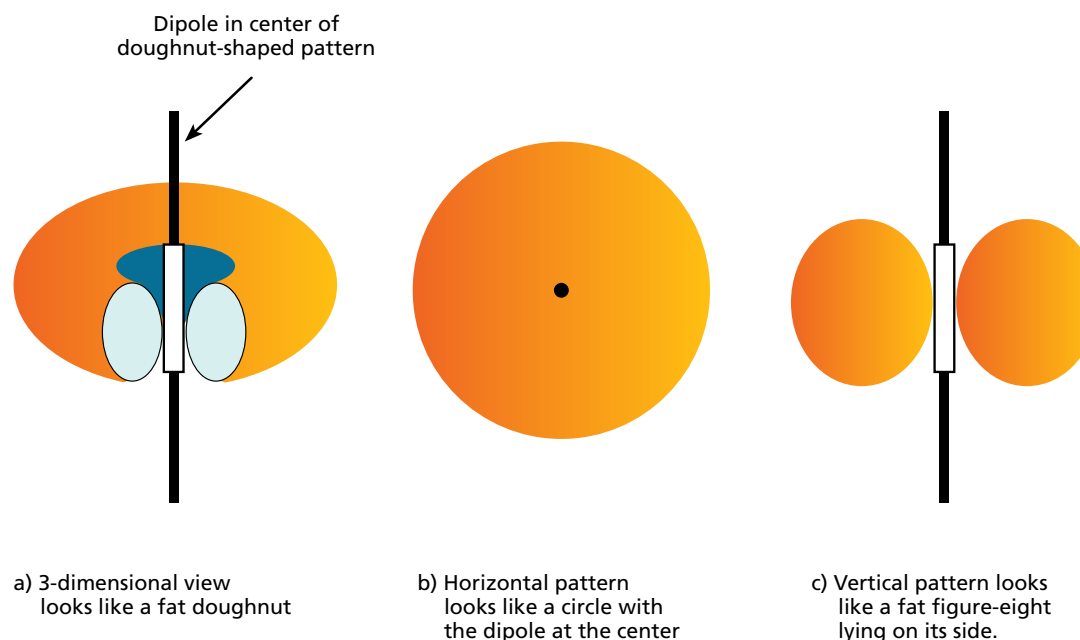

3.5: Radiation patterns for a dipole antenna

Imagine an antenna whose power input is distributed in an even isotropic manner. The directive gain is the radiated power density at a specific (theta, phi) coordinate relative to the isotropic radiation. Directivity is the maximum value of directive gain over the entire sphere.

The antenna's gain is the directivity multiplied by the antenna efficiency (see "What is an antenna," above). The antenna to the power input to the antenna. The difference between the antenna's input power and radiated power includes insertion

loss and power that is reflected back to the source due to impedance mismatches (i.e., the antenna VSWR). Antenna gain measured relative to an isotropic radiator is expressed in dBi (dB isotropic); when measured relative to the gain of a single dipole, it's stated in dBd (dB dipole).

Boosting gain

Since the input power is constant, the primary way to increase antenna gain, or maximize power density, is to focus more of the radiated power in a single direction. So, how do we do that?

A base station antenna radiates its energy both horizontally and vertically. One way to focus more radiated power in a single direction is to “squash” the vertical pattern. The effect is like squeezing a balloon; as the vertical beamwidth, the power density at the beam peak, the antenna gain, becomes larger.

Lower insertion loss, increase sustainability

Another way to increase gain is to reduce the insertion loss of the antenna. This is one of the ways in which antennas can be made “greener” since reduced insertion loss means the antenna can provide the same level of coverage while running the power amplifiers of the radio at a lower setting, conserving electricity.



Power ratio	dB	Power ratio	dB
0.10	-10	1.00	0
0.13	-9	1.26	1
0.16	-8	1.58	2
0.20	-7	2.00	3
0.25	-6	2.50	4
0.32	-5	3.16	5
0.40	-4	4.00	6
0.50	-3	5.00	7
0.63	-2	6.30	8
0.79	-1	8.00	9
1.00	-0	10.00	10

3.6: Deriving gain in dB from power ratios

Omnidirectional pattern gain antennas

To achieve greater gain in this circular (or omnidirectional) pattern, we can stack multiple vertical dipole antennas above each other, as shown in Figure 3.7. This increases the vertical size of the antenna. Then, we feed power to the dipoles in such a way that they add together at a distant point—again, with transmission lines matching their radiation power limits for greatest efficiency.

By feeding equal amounts of power that arrive at each dipole at the same instant, the dipoles radiate “in phase,” or in synchronicity, for improved gain by virtue of its pattern. This type of antenna is called a “vertical collinear phased array.”

Aperture

Beamwidth determines the gain of an antenna. Like an adjustable nozzle on a garden hose, beamwidth describes the degree to which the signal is focused: the tighter the focus, the greater the gain within that area of focus.

Spacing of dipole elements

In a vertical collinear array, each dipole or sub-array of dipoles is connected in parallel to the common feed point by a separate transmission line. Positioning the dipoles so they are closer together vertically tightens the overall beamwidth to boost gain. This separation is usually something between one half and one wavelength of the

assigned frequency being transmitted. Anything lower or higher tends to reduce the improvements in gain.

Feeding the array

In a vertical collinear array of two or more dipoles, the most common means of feeding power via the coaxial transmission lines is the parallel (shunt) feed. Power is fed along individual lines to each dipole or sub-array of dipoles. Using matching transformers and junctions, the cables connect to the line running down the tower. This allows the array to be fed from the center, equalizing the effectiveness of each array element and preventing the beam tilt that affects series-fed installations.

In phase

Multiple antennas radiating together at precisely the same time and rate.

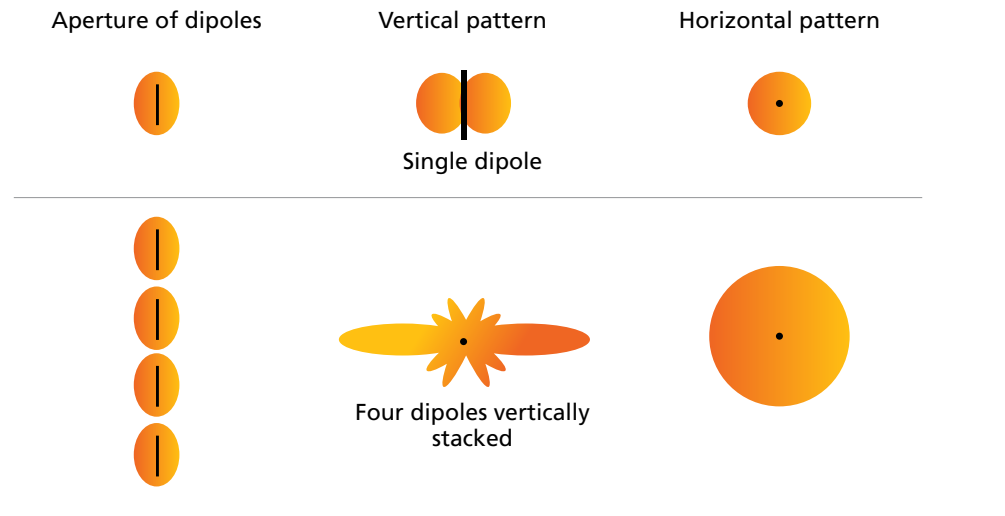

3.7: The maximum distance of the edge of the orange shape from the black dot at the center indicates the gain.

Directional gain antennas

While omnidirectional gain antennas like the vertical collinear array achieve greater gain by compressing its vertical pattern into a flatter circular shape, other types of antennas modify their horizontal patterns to accomplish the same gain improvements.

Dipole and reflector

As we've shown, a vertical dipole antenna has a circular horizontal pattern. However, if we position it in front of a metal screen or wire mesh, the radiation going to the rear will be blocked (Figure 3.8). If this blocked radiation is reflected off this screen, the horizontal pattern will no longer be circular, but directional.

If a dipole is positioned exactly one-quarter wavelength from this reflection screen, the radiation that would ordinarily go to the rear is redirected to the front to form what is called a "directional lobe." It's the same effect as that of the reflective mirror behind a flashlight's light bulb, which redirects the circular light pattern into a single direction. The larger the screen, the greater the reflection and the narrower the directional lobe—and, just as the omnidirectional antenna increases gain by compressing vertically, this directional antenna increases gain by compressing horizontally and directing all its power in a single direction.

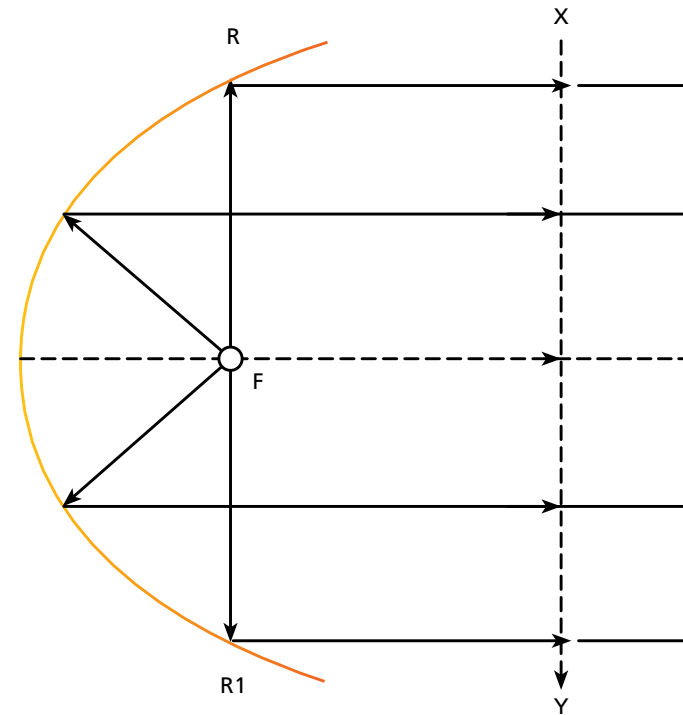

3.8: The omnidirectional pattern of a dipole can be made directional

The bandwidth factor

As we discussed in our description of the dipole, the length of an antenna is determined by the specific wavelengths it is designed to support. As you may recall, the dipole antenna must be half the length of its assigned wavelength. However, it is possible to build an antenna that covers a range of frequency bands—or bandwidth—centered on a particular frequency.

Indeed, nearly every antenna in use today can cover a wide swath of frequencies within a specific bandwidth. Certain antenna designs in the 1900 MHz frequency range can support over 61% of the 1427–2690 MHz bandwidth(). These are known as “ultra-wideband antennas.”

Cellular antenna concepts

Now that you have a basic working knowledge of antennas and how specific configurations can help them perform even better—for example, by improving gain—let’s zoom in on the cellular antenna.

In cellular base stations, there are two basic antenna types currently in use (Figure 3.9):

- 1. Omnidirectional antennas**, which exhibit a circular radiation pattern in the horizontal plane and operate in virtually all directions, and
- 2. Directional (or sector) antennas**, which operate in a specific direction, most commonly covering an arc of 120 degrees or less, depending on capacity requirements.

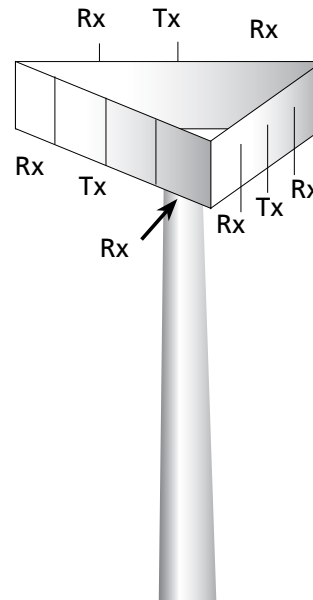

3.9: Directional antennas

Cell reuse

What makes cellular networks different from other types of communications is the principle of cell reuse. Cellular or cell reuse is a way of increasing network capacity by reusing allocated frequencies in a repeated pattern of cells. Earlier technologies such as 2G might reuse a frequency every third or fourth cell, but 4G and 5G systems reuse every frequency in every cell.

To see this process in action, consider the shape of cells and how they fit together. Typically, cells are represented as interlocking hexagons, as seen below (Figure 3.10). Depending on the density of the area served, these hexagons can be miles across or cover just a few hundred feet.

Thanks to this cellular design flexibility, channel sensitivity is limited by external interference rather than the noise issues that plagued older radio communications. Directional antennas, for example, enable specialized pattern shaping along the azimuth (horizontal direction) and elevation (vertical space) to deliver precise coverage that doesn't interfere with neighboring cells.

Antenna characteristics

A cellular base station antenna is the most critical consideration in creating an efficient cellular network; network efficiency depends on choosing the antenna with exactly the right physical characteristics for a specific application. These characteristics relate to radiation pattern, antenna gain, front-to-back ratio and other critical factors.

In the real world, defining, choosing and testing these characteristics requires technical expertise and more than a little math. For the purposes of this discussion, we will cover the basics with a far more generalized approach than an engineer would use in an actual evaluation.



3.10: Cell reuse in a sample map

Radiation pattern

Perhaps the most obvious and important characteristic to understand is an antenna's radiation pattern. If a particular application calls for coverage in all directions, you would choose an antenna with a circular or omnidirectional radiation pattern. If your installation requires a more focused signal, a directional antenna's radiation pattern makes more sense.

Mapping an antenna's radiation pattern is fairly simple and involves use of a probe antenna, a small RF sensor used to test antennas. The probe antenna is connected to a receiver. Moving the probe around the antenna under test or rotating the antenna in proximity to a fixed probe enables you to see the variations in signal strength. Mapping these readings with polar coordinates yields a three-dimensional map showing in which directions the antenna transmits most strongly (Figure 3.11).

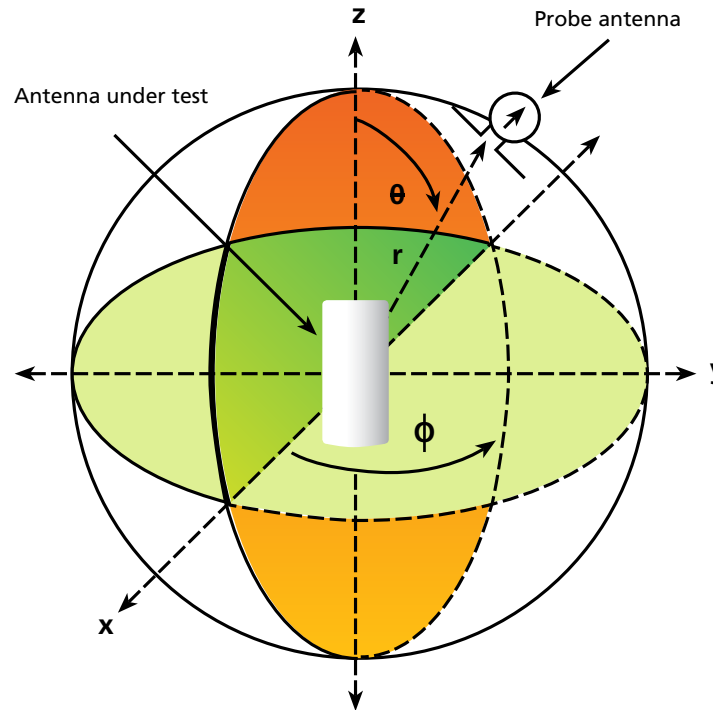

3.11: Moving a probe antenna around the tested antenna at a fixed distance yields a three-dimensional map of its radiation pattern

Radiation pattern

The three-dimensional shape of an antenna's strongest signal transmission.

Spherical coordinate system

A geometric polar coordinate system used to mathematically map the radiation pattern of antennas.

Azimuth coordinate system

The polar coordinate system used in the field by RF engineers and surveyors to map the radiation pattern of antennas.

An antenna's radiation pattern can also be expressed as a conventional rectangular plot whose X-axis represents the antenna's angle and the Y-axis is signal strength. Depending on its design, the antenna can radiate in any number of shapes (patterns). The isotropic dBi reference is a theoretical "point source" that generates a pattern covering all directions of a sphere. As seen previously, the half-wave dipole dBd reference pattern has nulls above and below the dipole and, thus—from a conservation-of-

energy standpoint—must have more gain on the horizon than the dBi reference. The absolute difference between the isotropic dBi reference and half-wave dipole dBd reference is 2.14 dB; however, most manufacturers today rate their products in dBi. Since an antenna's gain is determined by comparing it to one of these standards, the dBi rating will always be 2.14 dB greater than the dBd rating.

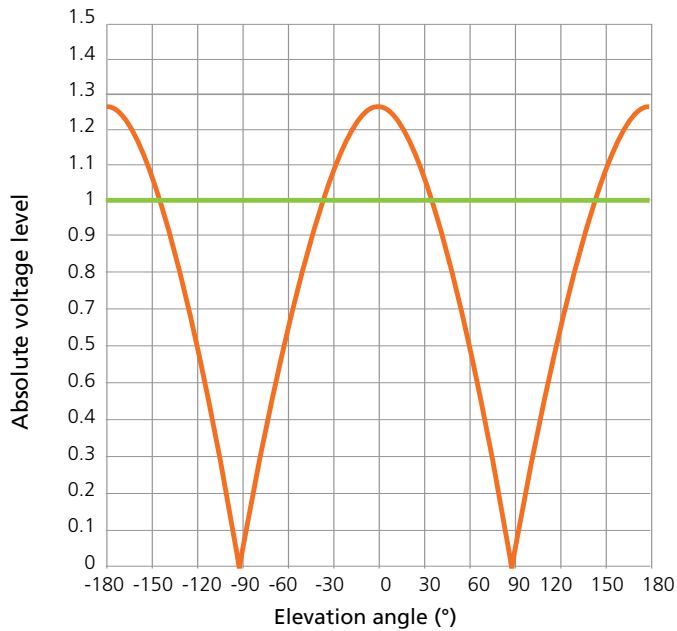

— Isotropic radiator
 — Half-wave dipole

Polar plot center = 0
 0.2 units/radial division
 15°/angular division

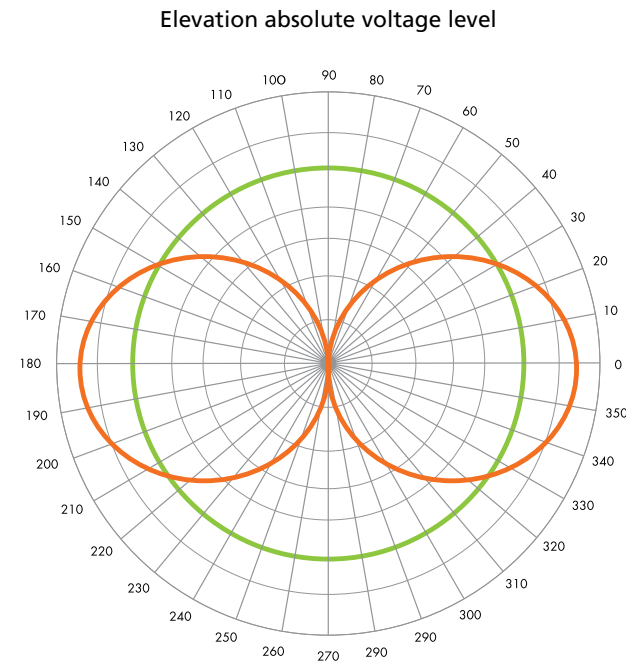

3.12: Rectangular and polar vertical pattern plots comparing isotropic radiator vs. half-wave dipole

Antenna gain

As discussed earlier, an antenna's radiation pattern is directly connected to its gain. As we increase the size of the antenna's aperture, the pattern becomes more "squashed" and the gain increases. For example, doubling the area of the aperture results in a doubling of antenna gain, or an increase of 3 dB (dBi or dBd). Larger antennas, however, introduce efficiency-reducing power losses that diminish the gain improvement.

Front-to-back ratio

The ratio of a directional antenna's maximum "front" directivity (where its main lobe appears) to its "back" (where its reflector is located) is the antenna's front-to-back (F/B) ratio (Figure 3.13). Note that F/B can be defined several different ways. For example, it could be defined based on the co-pol pattern, on the worst case of the co-pol and x-pol patterns, or on the total power pattern (pol plus x-pol patterns). In addition, F/B can be defined so the "back" is defined as the worst-case value over a sectoral range around the 180-degree azimuth point. For example, the BASTA committee has defined F/B as "total power over the 180 ± 30 -degree sector."

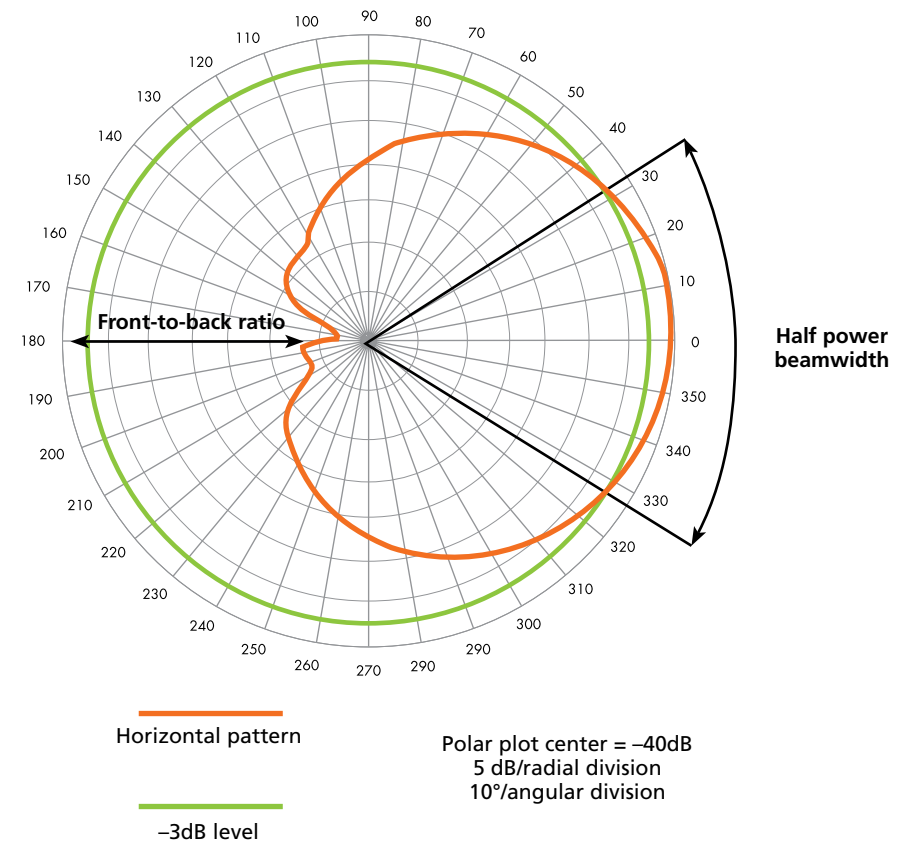

3.13: A polar representation of a directional antenna's front-to-back ratio

Sidelobes and nulls

Apart from a radiation pattern’s main lobe, there are also sidelobes and nulls. Sidelobes are extraneous areas of strong signal, and nulls are the low-energy spaces between them (Figure 3.14). Nulls may exhibit 30 dB or more of attenuation, meaning the null signal strength can be as weak as one one-thousandth of the power of the main lobe.

To reduce sidelobe signal strength and its potential interference, the amplitude and phase going into each element must be adjusted. This typically results in a widening of the main lobe and a reduction in gain. It is also possible to redirect the sidelobe power into the null. This process, known as “null fill,” typically results in a reduction in gain as well.

Polarization

Polarization is a property of the wave produced by an antenna; it describes how the wave varies in space over time. In simpler terms, polarization describes the orientation of the wave, such as vertical or horizontal or slant 45 degrees (dual-polarization).

Cross-polarization ratio

This characteristic measures how well a dual-polarized array can distinguish between two orthogonal waves (signals broadcast perpendicular to one another, such as

horizontally and vertically). This figure is calculated as the ratio of co-polarization to cross-polarization in the antenna’s main lobe (Figure 3.15).

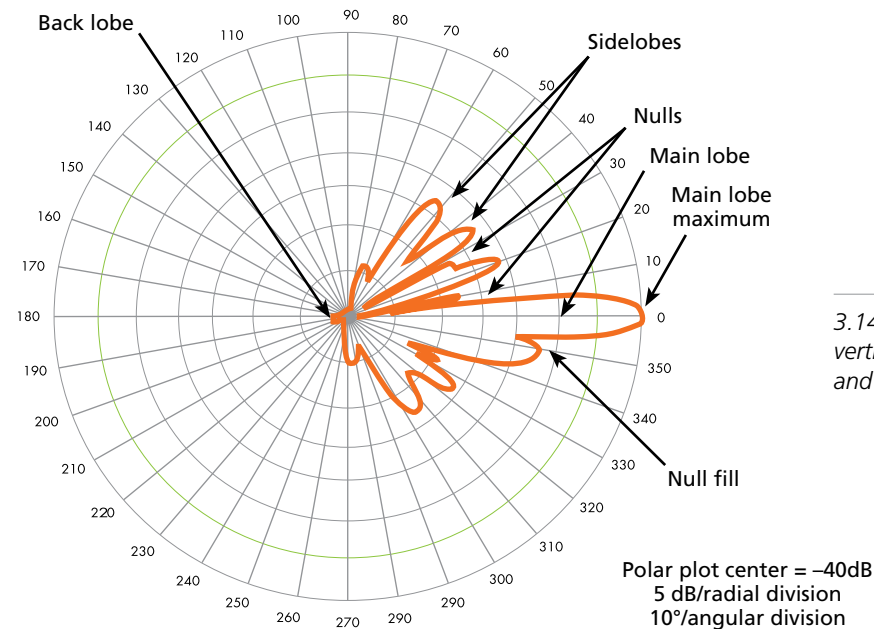

3.14: A polar representation of a vertical pattern including sidelobes and nulls

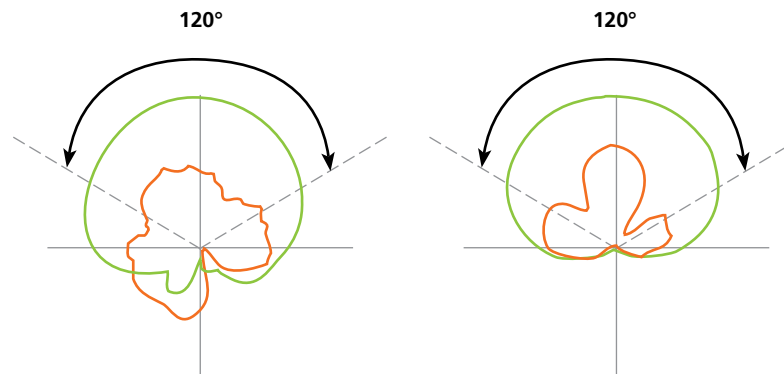

3.15: Typical and directed dipole cross-polarization ratios

Sector power ratio (SPR)

The sector power ratio (SPR) is the relative measure of signal power outside a receiving area versus signal power inside the area. SPR is a consequence of an antenna's radiation pattern (Figure 3.16); the lower the ratio, the better the antenna's interference performance.

As a practical matter, particularly in cellular network applications, a higher SPR indicates a higher amount of interference between antennas in adjacent coverage areas. When competing signals overlap, interference can increase and reduce performance. One result can be poor cell handoffs, where phone calls can be dropped while moving from one cell to another. Cellular networks require precise sectorized planning to prevent this kind of problem.

Beamtilt

As capacity requirements increase, one solution is to split the hexagons (see Figure 3.10), allowing the addition of more sites and reducing the coverage radius of the original site. To accomplish this, elevation beam downtilt is commonly used to reduce the gain on the horizon (and thus the coverage radius), as shown in Figure 3.17. Mechanical downtilt results in undesirable pattern distortion on the horizon, while electrical downtilt maintains the desired pattern shape. Early antennas

incorporated fixed electrical downtilt, but this required multiple different models. State-of-the-art antennas today have adjustable electrical downtilt, which can be adjusted remotely using the architecture and standards published by the Antenna Interface Standards Group (AISG).

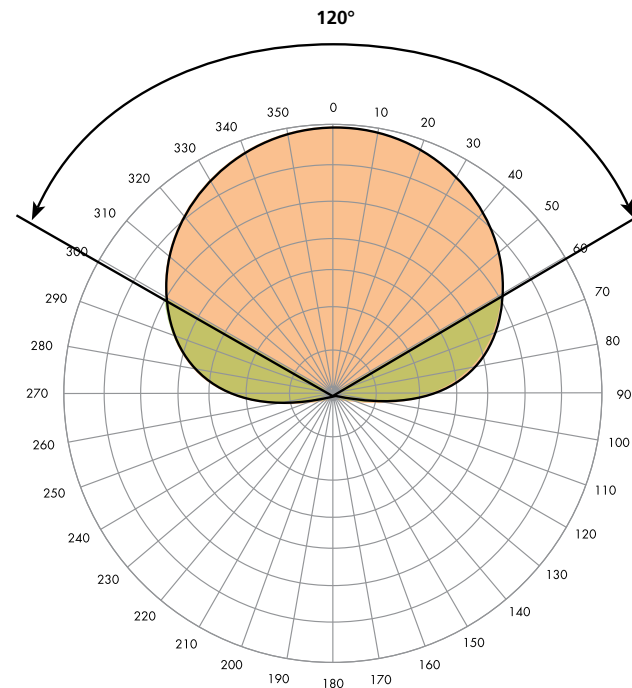

3.16: Graphic and mathematical representations of an antenna's sector power ratio

Cellular antennas on a practical level

When we move beyond theoretical antenna design to the real world, we soon discover that the laws of physics are not the only limiting factors affecting an actual installation. These issues include everything from tower weight and wind limits to local zoning board approvals for antenna size, shape, height and appearance. In most installations, compromises are necessary to satisfy all the competing interests.

Most cellular antennas are produced in a variety of physical sizes to offer the best performance while conforming to other requirements. Chances are you've seen cellular antennas mounted in a number of ways, featuring diverse sizes and designs—such as the commonly used lengths of 4, 6 and 8 feet. Outside the U.S., common lengths are 1.4, 2.0, and 2.7 meters.

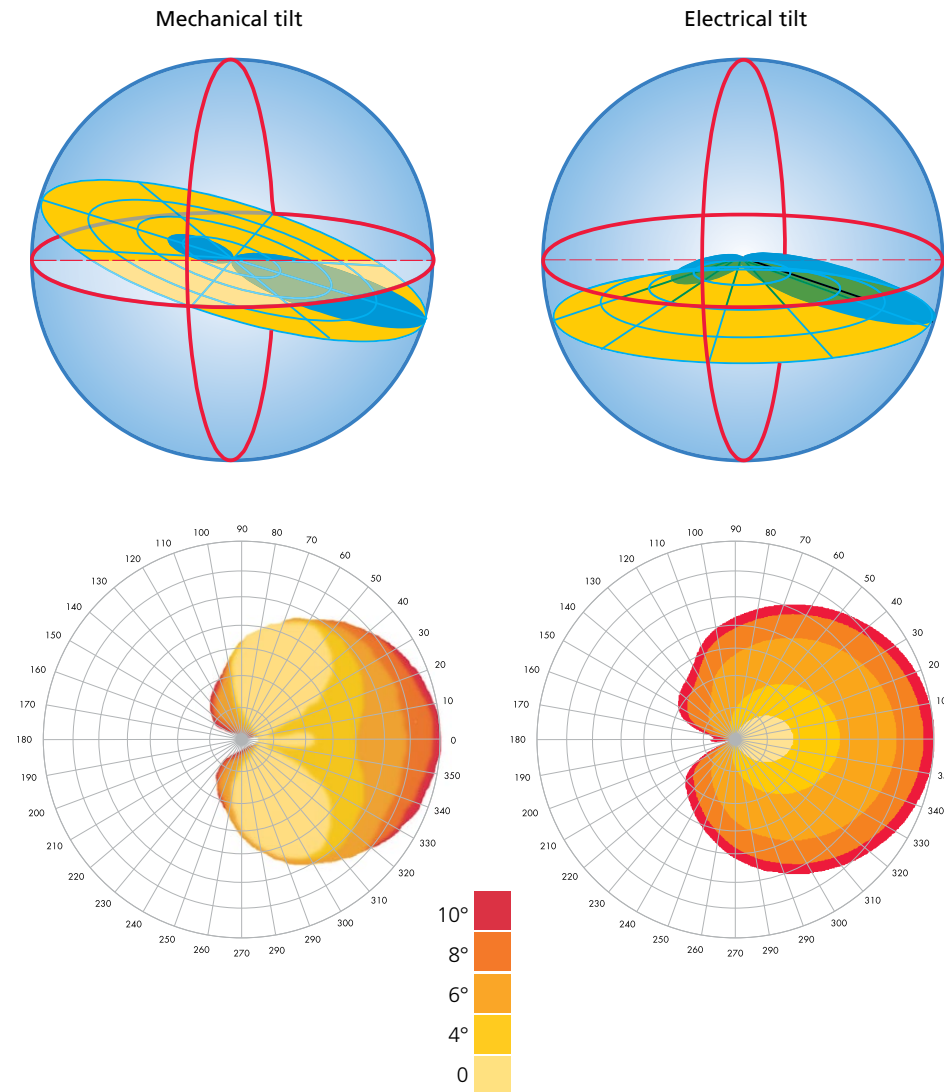

3.17: Tilting the antenna changes the shape of the lobe at ground level, reducing gain

Antenna profiles and tower/wind load

The size and shape of an antenna dictate not only its function, but also how much stress it places on the structural members holding it on to the tower. Because cellular base station antennas are typically located high above the ground, they experience greater wind speeds and gusts than one might notice at the base of the tower. Antennas act like sails, catching the wind on their flat surfaces to create “wind load,” a measure of the stress wind places on the tower and antenna mounts. Therefore, where possible, antennas should be designed with the smallest, most aerodynamic form factor.

A smaller size also means less weight, which improves the antenna’s “tower load” characteristics, or the combination of the antenna’s weight plus the force generated by wind loading. All cell site towers have a maximum load rating; so, by adding antennas, one reduces the tower’s remaining load budget. This is increasingly important as more and more cell site equipment is being mounted on the tower instead of in the shelter at the base.

Moving to smaller antennas also increases the network’s sustainability by lowering the overall carbon footprint. This is because reducing the antenna’s size (and weight) typically reduces the

amount of material needed and the CO₂ output from the production processes. The same applies to the antenna packaging materials. Finally, reducing the size of the antenna packaging materials allows a larger number of antennas to be placed in a shipping container or truck trailer, which reduces the amount of energy consumed to deliver the antenna to its destination.

Materials and environment

Cellular base station antennas are only as reliable as the materials that go into their construction. When it comes to working with the physical limitations of an antenna’s location, matching the right materials to the environment is critical. Here are just a few examples.

In the antenna array itself:

- Aluminum alloys offer lightweight increased strength but can be vulnerable to the elements.
- Pressure-cast aluminum is well suited to bases, sockets, mounts and clamps, where its hardness and resistance to corrosion are critical.
- Where weight is not a serious factor, copper and brass are used for their easy plating and conductive properties. However, they need to be protected to prevent corrosion.

Antenna radomes:

- High-strength, low-RF loss materials such as fiberglass—or thermoplastics such as ASA or PVC—offer protection from the elements.
- Materials must offer UV protection to prevent deterioration due to sunlight exposure. This can be done via a coating or by adding UV inhibitors to the base polymer.

Radomes go green

CommScope now manufactures many of its new radomes with GFRPP (glass fiber reinforced polypropylene), a lightweight synthetic material that is also 100% recyclable.



Tower appearance:

- For improved aesthetics and faster regulatory compliance, nonmetallic paint can be applied to the entire structure.
- For better wear, smooth surfaces should be roughed prior to painting.

These are just a few of the more obvious physical considerations. Others such as cable selection, connector choice and termination options should also be evaluated.

More capacity with fewer antennas

As mentioned earlier, cellular antennas are directional, often covering 120 degrees. Mounted together on a triangular tower, these antennas can cover all directions. In dense urban areas, sector splitting with narrowbeam antennas provides more capacity to handle additional traffic. But this configuration also means more antennas and more costs. Increasing the number of antennas in a single location also increases the chances of running afoul of local zoning codes and increasing tower loads and wind loads.

Multibeam antennas enable you to add capacity without adding more antennas. A multibeam antenna splits the main beam into precisely spaced narrower beams. Multibeam antennas are particularly effective in areas of high network demand like stadiums and outdoor venues. For temporary high-capacity coverage, many operators will mount multibeam antennas on a COW (Cell on Wheels)—a truck with the required radios and a telescoping mast to elevate the antennas.

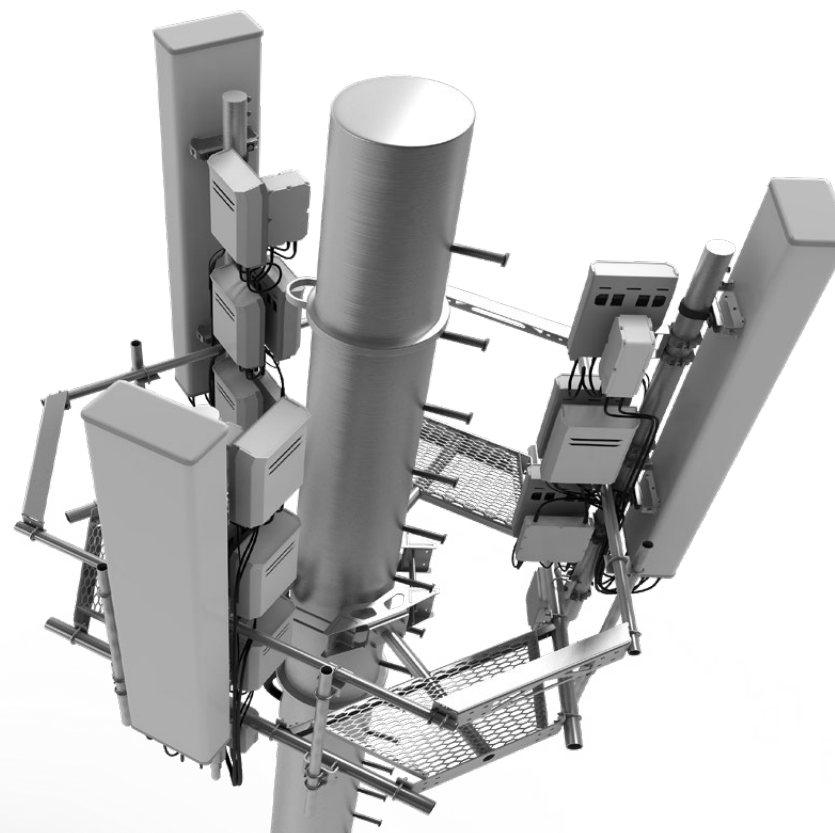

Twin-beam

One example of multibeam technology is the twin-beam antenna from CommScope. It produces two separate 35-degree beams with centers separated by 60 degrees. As the illustration below shows, this dual-lobe approach provides excellent coverage and only requires three twin-beam antennas instead of six narrowbeam antennas to provide a six-sector scheme (Figure 3.18).

“Six-sector” sites

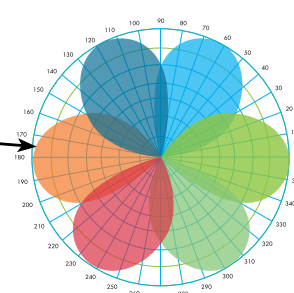
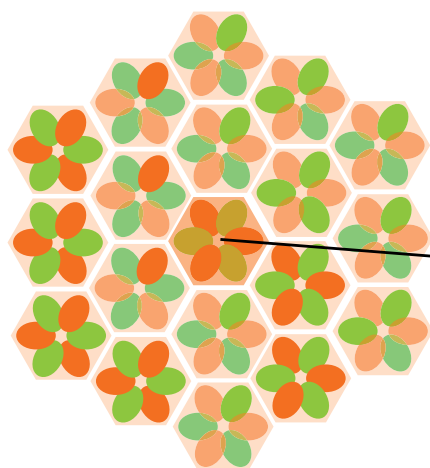

65° antenna vs. twin-beam antenna

Traditional 65° pattern

Better roll-off

Wider coverage

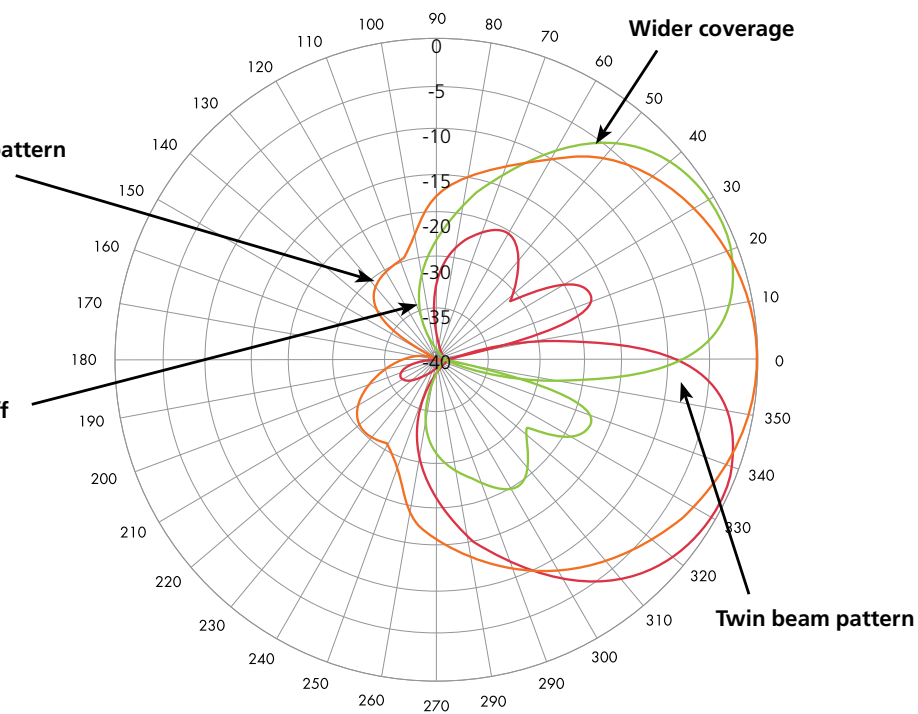

Twin beam advantages

- Back-to-back broadCast channel (BCCH) re-use capability
- Enhanced RF footprint (higher gain)
- Better interference containment (better roll-off)
- Easier zoning and faster site deployment

3.18 Same number of antennas, double the coverage—a 65° pattern compared to a twin-beam installation

Beamforming

Beamforming is a capacity-boosting option in which the antenna elements steer a beam toward each user on a tightly managed time-division basis. It involves a multiport antenna and correlated amplitude and phase weights generated in the radio. This produces narrower beams that optimize the SINR by increasing the link budget to the intended UE or by decreasing the link budget to other UEs that may generate interference. This increases

both capacity and coverage to improve spectrum reuse and reduce interference. Managing a beamforming system for a large number of users requires powerful and sophisticated digital processing, but it can effectively “null out” nearby interference for better high-speed throughput (Figure 3.19).

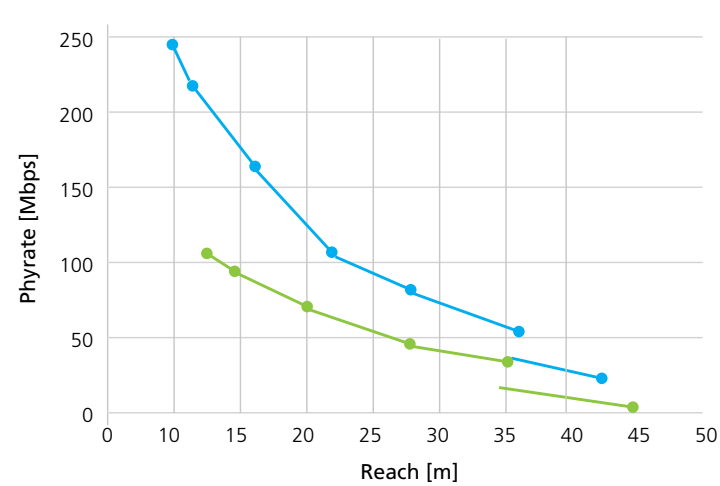
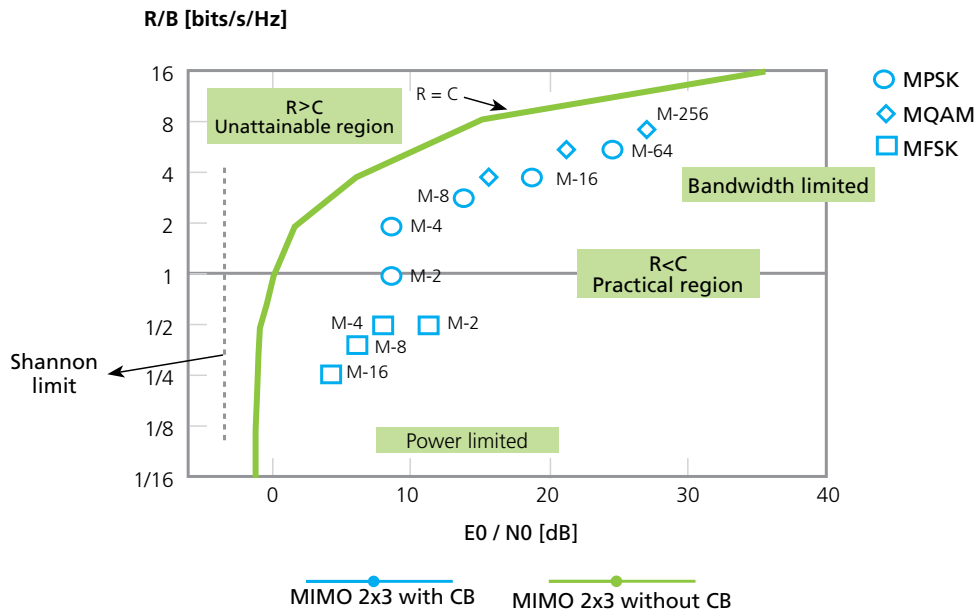

3.19 A traditional plot of Shannon's limiting law

MIMO

New wireless technologies are being developed and deployed at a dizzying rate. The current field of cutting-edge engineering is collectively known as “long-term evolution” (LTE) networks. With the opportunities enabled by “multiple input, multiple output” (MIMO), LTE has the potential to completely reshape how networks perform. MIMO splits data transmission into multiple streams and sends them simultaneously on the same frequency using multiple de-correlated RF ports.

What makes this development so exciting is that MIMO offers a way around a classic limiting factor of RF communications known as Shannon’s law, which dictates how much throughput can be delivered down a given amount of bandwidth. As Figure 3.19 shows, you can only expect to get to within 3 dB of a bandwidth’s theoretical maximum in a practical application.

TR configuration and MIMO rank

A transmit/receive (TR) configuration refers to the number of radio transmitters and receivers in one sector. Increasing the number of transmitters increases the base station capabilities in terms of transmit diversity, MIMO transmission modes and beam steering.

A MIMO rank describes the number of streams (layers) entering and exiting a communications channel, for each duplex mode. For a DL 4x4 MIMO, four streams enter and four streams exit the air interface in the downlink direction.

2T2R, 2T4R, 2X and 4X MIMO

2T2R refers to the base station radio’s configuration to transmit on two separate streams and receive on two separate streams. 2T4R refers to a base station radio’s configuration to transmit on two separate streams and receive on four separate streams.

2x2 and 4x4 MIMO refer to the configurations used to transmit and receive the respective number of streams. For example, 2x2 MIMO refers to the transmitter’s ability to transmit two separate streams and the mobile’s ability to receive two separate streams. 2x and 4x MIMO refer to the base station radio transmitter configuration only.

MIMO circumvents this limit through digital signal processing (DSP), which can distinguish between the two split signal paths and reassemble them into the original data on the receiving end. This workaround literally doubles the theoretical limits defined by Shannon’s law when applied in a 2x2 MIMO configuration with two transmit and two receive antennas (Figure 3.20).

Shannon’s law

Created by Claude Shannon and Ralph Hartley, this law establishes a theoretical limit to how much data can be reliably pushed through a given amount of bandwidth.

The benefits of DSP are quadrupled in a 4x4 MIMO configuration with four transmit and four receive antennas. Actual throughput improvements do not quite achieve this degree of volume, but that differential is to be expected in any practical application of theoretical performance.

MIMO systems
2 x 2 SU-MIMO: Spatial multiplexing

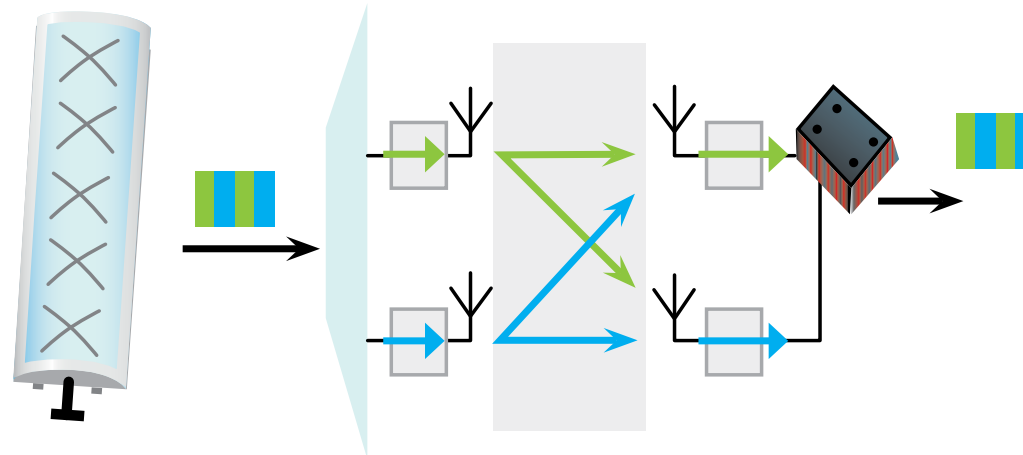

Same time and frequency resource

- Multiple input multiple output
- Capacity gains due to multiple antennas at both ends of the link
- Multipath provides additional channel using DSP
- LTE supports 1x2, 2x2, 4x2, 4x4
- Spatial multiplexing requires a multi-path environment

Different data streams

- Space Time Block Coding is a transmit diversity mode used when SINR levels cannot support spatial multiplexing
- Decorrelation between antennas and propagation paths required for spatial multiplexing
- A dual polarized BSA for 2x2 MIMO; two separated for 4x2 or 4x4 MIMO
- Alternatively, vertically polarized antennas can be used with spatial separation

3.20: This 2x2 MIMO system uses digital signal processing to circumvent theoretical throughput limits

Massive MIMO and 5G

MIMO's capacity-magnifying effect sees its ultimate expression in massive MIMO (M-MIMO), which is already coming to market in certain parts of the world. Scaling up the grouped antenna architecture of MIMO to include dozens, hundreds or thousands of antennas has proven to yield remarkable improvements in network speed, capacity and efficiency.

In 2017 a wireless operator using a 4G M-MIMO antenna was able to increase a single 20 MHz channels capacity by 300% by using a 64T64R M-MIMO antenna system instead of the more typical (at that time) 8T8R system. This degree of capacity and speed magnification will be essential to the coming rollouts of 5G wireless services, which will require vastly increased performance and lower latency than current LTE wireless networks.

Chapter 3 summary

Antennas:

- Structures that radiate and receive radio energy
- Can achieve 80 percent efficiency or greater
- Directional (sectorized) or omnidirectional

Performance characteristics:

- Radiation pattern
- Polarization
- Gain
- Beam width

Enhancements through design:

- Vertical stacking
- Element spacing
- Horizontal pattern shaping
- Downtilt

Cellular base station antennas:

- Sectorized, grouped antennas commonly covering 120 degrees or less

The background of the slide features a photograph of a telecommunications equipment room. The room is filled with rows of tall, grey metal cabinets housing various electronic components and a dense network of cables. Two technicians, wearing hard hats and safety harnesses, are positioned on a scissor lift platform, working on the equipment. The entire image is overlaid with a semi-transparent green filter. The bottom of the slide has a solid orange-to-green gradient bar.

Chapter 4

Working within the limits: Co-siting solutions

Carpooling neighborhood kids to school is a great way to manage household costs—under the right circumstances. It allows more people to be moved with less infrastructure, for each participant to spend less on gas, and also helps reduce the overall density of traffic on the road. However, it’s not always the best solution. Carpooling also limits where and when passengers can go—reducing overall flexibility in routing, speed and efficiency.

This tradeoff between cooperative advantage and individualized flexibility applies to wireless networks as well. Here, “carpooling” is co-siting.

The economic case for co-siting wireless network infrastructure can be pretty compelling. With space at a premium, there are real incentives to reducing your equipment footprint and the associated OpEx; however, every square foot saved places new constraints on the way that base station operates. Since every site has unique limitations, it can be a challenge to identify and implement the best co-siting solutions that optimize the balance of benefits for all concerned.

Going back to our initial carpooling metaphor, we can think of different sharing models available to suit our participating families. For instance, they might split their vehicles’ cost and recruit a shared driver. They can even sell their vehicles and hire a taxi company to drive their kids for a monthly fee (corresponding to a tower companies model). More on these models below.

Whatever the specifics of a given cellular installation, CommScope offers a wide range of solutions that meet virtually any installation requirement. It takes a combination of technology and insight to make the best of every situation.

Dealing with the realities

Just as it would be supremely convenient to have your own vehicle and driver, it would be ideal for cellular base stations to be equipped with their own dedicated towers, antennas and feeders at every cell site (Figure 4.1A).

If such an arrangement were possible in every installation, the benefits could include:

- Individually optimized antenna pattern, azimuth direction and downtilt angle
- Minimal RF path loss and signal mismatch

Co-siting solutions

The technology and practices that allow multiple operators or technologies to share a physical site architecture

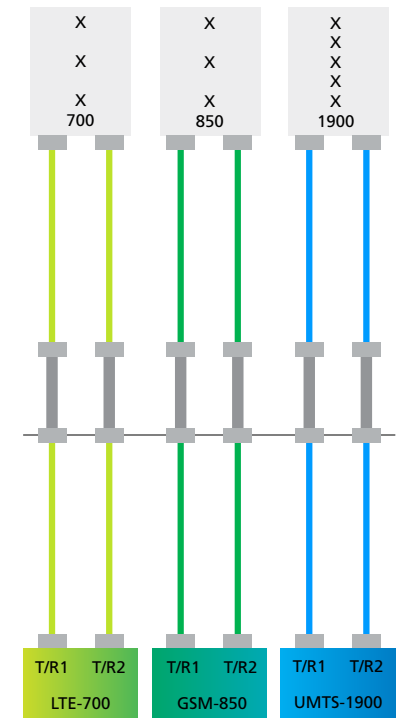

4.1A: Multiband sector with separate feeders

- Reduced interference and intermodulation between systems
- The ability to perform maintenance on one system without impacting the others

Sadly, this arrangement isn't a practical option for most real-world designs. When a cellular base station makes the move from the drawing board to the tower installation, its design becomes subject to an incredible number of variables and limiting factors. Some of the more common limits are:

- Local zoning ordinances that restrict quantity, size and location of antennas
- The tower's structural weight limits and wind load restrictions
- Budget constraints that limit both the initial (capital expenditure, or CapEx) costs and ongoing (operational expenditure, or OpEx) costs
- Scheduling demands that require accelerated service rollouts

Network sharing models

Network sharing has been in use since the early 2000s when it was used to mitigate the onerous costs of deploying new 3G infrastructure in Europe. It gained additional importance when 4G/LTE deployments began to heat up there in 2015, again in response to costs.

In general, network sharing is a cooperative agreement between two or more wireless operators to use common infrastructure including, antennas, backhaul capabilities, base stations and even core networks themselves. It's estimated that these arrangements can reduce CapEx and OpEx spending by 10 to 40 percent for each participating operator.

The major driver of network sharing continues to be the potential for cost savings. The amount that an operator can save depends upon the depth of the sharing arrangement. Options range from real estate and infrastructure to active forms in which a common RAN network, spectrum resources and core networks may be shared among MNOs. The potential cost savings and benefits increase as the depth of the sharing increases, but so do the risks. An overview of the most common network sharing models is illustrated in Table 4.1B.

Site sharing	Civil infrastructure
	Backhaul
Passive sharing	RF path
	Antennas
Active sharing, MOCN, MORAN	Base station
	Controllers
	Spectrum
GWCN	Core network

4.1B: Popular network sharing models

Despite some 3GPP efforts, there are no standard sharing terminologies, architectures or classifications in the industry. Encountering different names for the same sharing type is very likely. Even the term “sharing” itself is referred to by “colocation” in some markets. However, all terminologies involve three main sharing categories:

- **Site sharing.** Shared assets may include the physical real estate for the site, space on a tower, cabinets or enclosure spaces, and any utility connections supporting the site. This has become an extremely common practice, and is even mandatory in some markets.
- **Passive sharing.** This is the sharing of passive, or non-electronic, components needed to support a cell site, such as antennas and transmission lines, tower-mounted amplifiers and other RF conditioning equipment.
- **Active sharing.** This refers to the sharing of active electronic infrastructure and radio spectrum used in the RF path, such as base station radios and controllers, as well as operational resources such as maintenance, radio design and planning. Operators can share not only spectrum, but core network, infrastructure management systems, content platforms, and administrative resources like billing systems and even customer service platforms. Less common than passive sharing, it is nonetheless becoming more widespread to support 4G/LTE rollout costs. More on this below.

- **National roaming.** This is the practice of sharing responsibility for coverage and capacity by dividing costs between participating operators based on geography—in some ways like how separate railway lines share coverage of specific routes and areas with each other in a mutually beneficial way. This practice also gives entrée to new operators who do not own a physical network, but can contract to ride on another operator’s infrastructure to ensure consistent QoS and equitable pricing.

Passive sharing techniques

Multiband combining

One frequently used passive sharing technique is called “multiband combining,” a method of frequency multiplexing. It takes advantage of the fact that feeder cables are naturally well suited to being shared by multiple frequency bands. In other words, multiple base station services can be funneled into a single feeder cable that runs up the tower to the antennas. Those services can then be split away from that one cable directly beneath the antennas.

To visualize this concept, think of how you bundle your home or office computer’s wires into a single plastic cable wrap. At one end, the cables separate into various

3rd Generation Partnership Project (3GPP)

A collaborative coalition of telecom associations originally formed to create global 3G specifications. 3GPP has since added standards for 4G/LTE and other technologies.

ports on the back of your computer. On the other end, the cables separate into your keyboard, mouse, network and printer connections. In between, they are combined into one slim run that reduces space requirements and complexity.

To achieve the benefits of frequency multiplexing, the feeder cable must be equipped with the correct combining devices. Two or more frequency bands can be combined using multiband combiners. Multiband

combiners (MBCs) are often added to a system as separate components, but they can also be built directly into other components such as antennas.

Widely known as “crossband couplers,” these combiners may be referred to as “diplexers” (two frequencies), “triplexers” (three frequencies), and so forth according to the number of frequency paths involved (Figures 4.2 and 4.3).

Multiband combining

A configuration that combines multiple frequency bands into a common RF path, such as combining multiple operators or technologies operating on different bands.

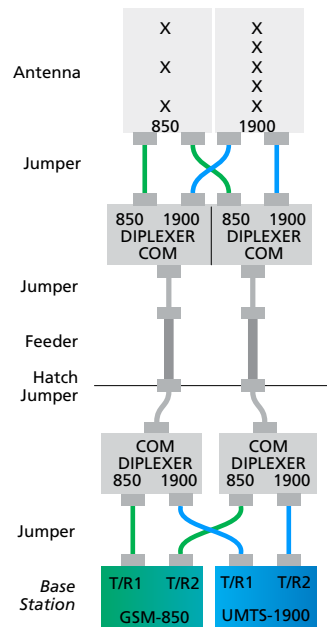

4.2: Shared feeders using diplex crossband couplers

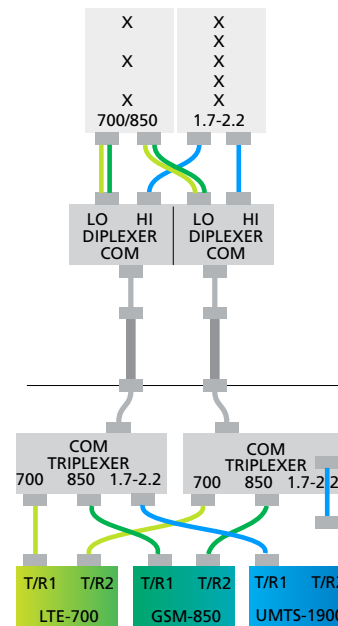

4.3: Shared feeders using triplex crossband couplers, with broadband antennas using diplex crossband couplers

The kind of MBC required in a particular application is determined largely by the frequencies the system uses, and, more specifically, how far apart from each other those frequencies are. In systems with wide frequency separation—such as 700-1000 MHz, 1700-2200 MHz and 2400-2700 MHz—the needed MBCs are likely to be low-cost, compact devices that introduce virtually no loss or mismatch.

However, when dealing with frequencies that are relatively close to one another—such as 700 MHz and 850 MHz—the appropriate MBC tends to become larger and more complex (Figure 4.4).

On the antenna side of the connection, additional efficiencies can be gained among broadband antennas that can accept more than one frequency through a single port. This allows it to operate over a range of bands through one feeder cable, as previously shown in Figure 4.3.

Like the other circumstances involved in planning an efficient and compliant base station site, antenna selection and the base station's assigned frequencies can play a large part in how a particular co-siting solution comes together.

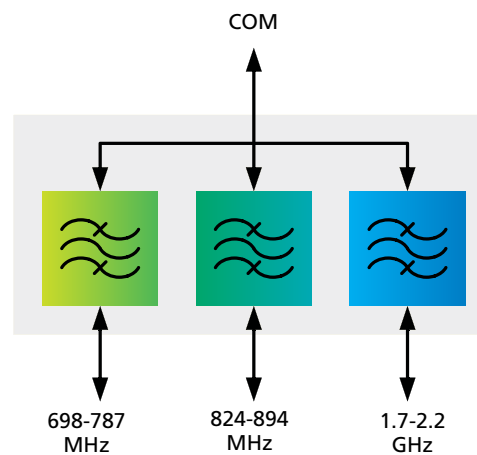
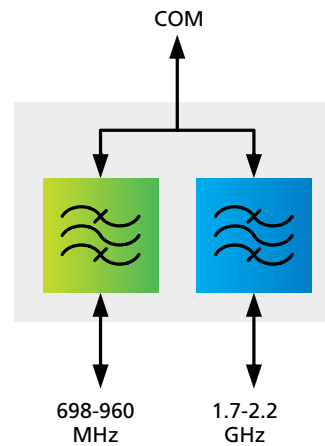

4.4: Compact diplex and triplex crossband couplers, with example frequency differentiation

Same-band combining

In some instances, multiple services require the use of the same frequency band. When this happens, multiband combiners—which are designed to suit specific frequency separation—don’t provide the solution we need. Instead, we can use a variety of same-band combining (SBC) options, which can allow different services to share the same space on the electromagnetic spectrum.

In some applications, same-band combining is even used for single-service systems—not to allow other services, but to increase the channels available to the one operating service. In all cases, the idea is to combine transmit signals (TX) and divide receive signals (RX). The best way to achieve this depends on the specifics of the application.

Now let’s look at some of the more commonly used techniques.

• **Hybrid combining**

Hybrid combiners offer a low-cost means of combining TX signals and dividing RX signals (Figure 4.5), but this advantage comes at the cost of other operational restrictions inherent in its design.

The main disadvantage of this technique is the high rate of loss experienced in both directions. This loss increases with the number of ports involved, so hybrid combiners are generally used only in two-port applications.

Another consideration is the significant heat it generates, which must be dissipated—adding costs and creating even more design limitations. These drawbacks limit the practicality of hybrid combining to in-building coverage and similar uses. It is rarely used in cellular sites.

Same-band combining (SBC)

A configuration that combines multiple services, carried over the same bands, into a common RF path. Such as combining multiple operators or technologies operating on the same bands.

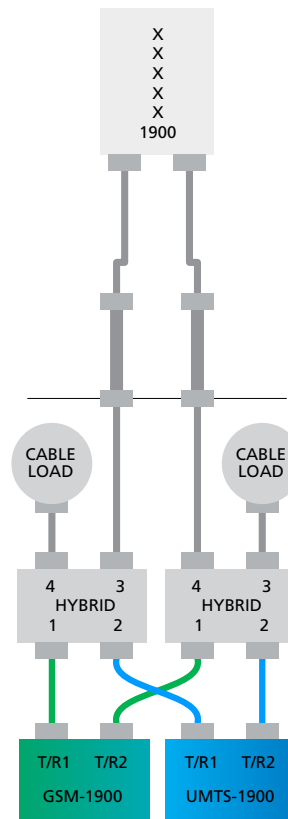

4.5: A hybrid combiner, using cable load to lower passive intermodulation

• **Low-loss combiner-multiplexers (LLCs)**

LLCs offer a different way to combine base station transmitters. Integrated duplexers allow combining of TX signals and distribution of RX signals as well (Figure 4.6).

Like the multiband combiners discussed earlier, the LLC is a filter multiplexer. However, unlike an MBC that requires spaces between bands (recall that the bigger the spaces, the better the combiner operates), the LLC handles frequencies inside the same bandwidth. This is possible due to the addition of guard bands, which act as very small gaps within the band. They create boundary spaces between the frequencies—allowing them to be distinguished from one another.

Including these tiny guard bands often requires those narrow frequencies to be left unused, which adds up to slight bandwidth loss. In LLC design, smaller guard bands incur greater cost, size and complexity, so an economical alternative is to re-use the “lost” guard band space with a second feeder and antenna.

LLC design significantly reduces insertion loss over that of a hybrid combiner, but its reliance on filter multiplexing places significant restrictions on its

scalability. As technology develops, networks require constant upgrading, adjusting and scaling—which often entails replacement of the LLC component.

Several examples of LLC realizations are shown in Figures 4.7 and 4.8 on the following page.

Guard bands

Narrow gaps kept between adjacent bands to minimize interference. Used by the low-loss combiner (LLC) to distinguish between different signals riding on combined bands.

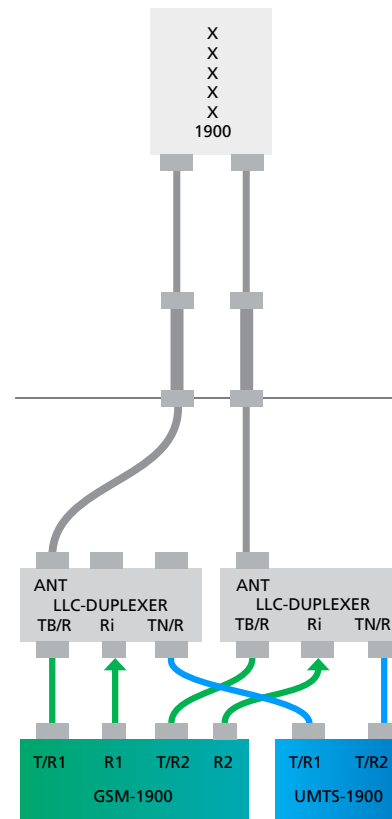

4.6: An LLC with integrated duplexers; RX distribution from GSM BTS

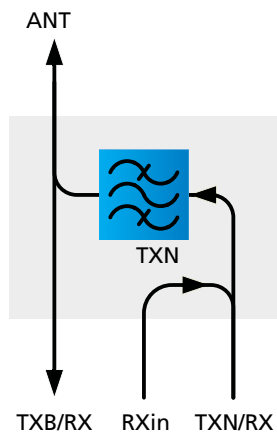

4.7: An LLC combines a narrow portion of TX band into broadband path; includes duplexer for RX re-injection

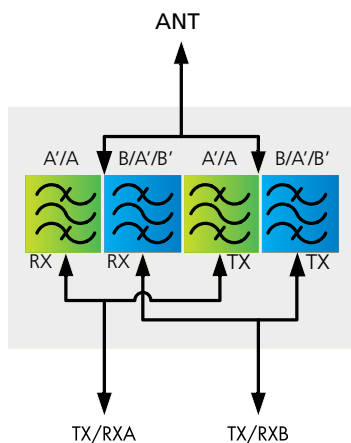

4.8: Filter multiplexer for downlink and uplink—a quadruplexer

• **Multiport antennas**

Today’s multiport antennas provide an excellent opportunity for mobile network operators (MNOs) to take advantage of antenna sharing while retaining control of their individual antenna elements and coverage patterns. Current modern multiport antennas are able to support ultra-wideband spectrum and multiple RET controllers, enabling sharing mobile operators to individually optimize their tilts electrically and expand their frequency band allocations, without physically modifying the antenna. An example is shown in Figure 4.9.

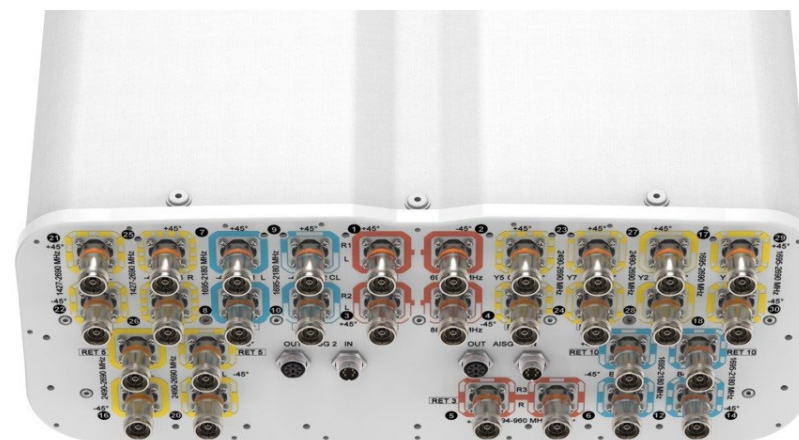

4.9: A multiport antenna panel

Sharing antennas—and co-siting antennas

A site’s antennas are unique in that they are key considerations in both passive and active network sharing agreements. The variety of network sharing scenarios in which they are used has led to manufacturers engineering a high degree of versatility into the antenna’s architecture.

Therefore, base station antennas have evolved to become highly complex, and their proper use in network sharing arrangements can be complicated. Antenna sharing between multiple operators, for example, can be seen as so restrictive in terms of available degrees of optimization that it may seem more economical to simply add another (unshared) antenna instead.

In fact, an August 2015 regional market survey conducted by CommScope sales teams estimated the instances of antenna site sharing to be approximately 100 or fewer per operator in the Middle East and Africa, and virtually unheard of in North America and Europe. At the same time, co-siting individual antennas is a common practice in both North America and Europe, illustrating the economic issues driving the continued global rollout of 4G/LTE.

Sometimes, however, economy is not the only factor to consider. In some countries, such as Brazil, Canada, Jordan and Egypt, aesthetic, environmental, health or safety regulations force antenna sharing into play as a condition of the operators expanding their networks.

There are two basic solutions to antenna sharing: use of multiport antennas or deployment of combiners.

As illustrated in Figure 4.10, the biggest challenge when deploying multiport antennas in support of a shared network is the larger physical size of the antenna and the resulting increase in tower loading. This is especially problematic across multiport antennas in the lower frequency bands, where the array is larger to begin with.

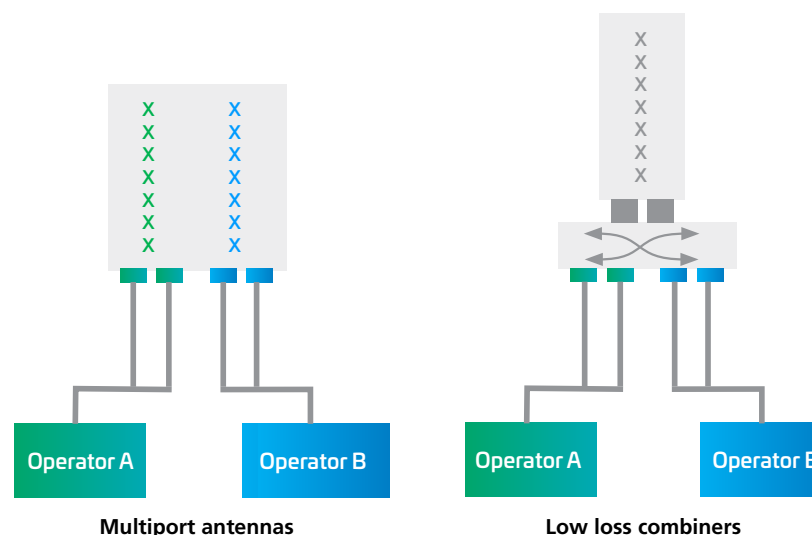

	Multiport antenna sharing	Combiner sharing
PROS	<ul style="list-style-type: none"> • Multi BTS RET control after mods • Normal PIM and VSWR risk • Lower RF path losses • Can re-allocate bands in future 	Normal antenna size and tower load for all bands
CONS	Increased antenna size and tower loading for low bands	<ul style="list-style-type: none"> • Higher PIM and VSWR risk • Increased RF path losses • Does not support multi BTS RET control • LLC fixed for existing bands

4.10: Multiport antennas and MBCs/SBCs allow for antenna sharing where it is required.

MNOs can also choose to deploy multiband or same-band combiners as an alternative to multiport antennas. This reduces the required number of antenna arrays and enables the operator to minimize the antenna size and tower loading. This type of solution is often used to deploy an LTE overlay onto a network's legacy services.

However, this approach also has drawbacks. Operators give up independent RET control and risk higher incidences of passive intermodulation (PIM) and VSWR. There are also greater RF path losses and, in order to add or change frequency bands, combiners may need to be replaced.

While either multiport antennas or combiners can be used to enable antenna sharing, the best solution may be a combination of both. Using a combiner for the low bands and a multiport antenna for the high bands takes advantage of the strengths of both technologies while minimizing the weaknesses. Certain antennas are available with factory-integrated combiners—reducing interconnections, allowing individual RET control and saving space on the tower but also offering less flexibility as to the bands that can be combined.

Antenna sharing capable antennas

So how can an operator ensure it maintains control of its own traffic on a shared antenna? In most cases, multiport antennas will provide the required flexibility, RF performance and pattern control. However, to realize these benefits, the antenna must provide independent remote electrical tilt (RET) control for each operator—a capability not inherently available with all multiport antennas—so operators must either purchase new multiport antennas equipped with independent RET control or, in some cases, implement using external hardware.

RET uses an open platform developed by AISG. AISG's standards have led to improvements in RET control and monitoring, as well as reporting alarms and other important advances in remote management. Operators sharing antennas need to independently control their RETs through separate AISG inputs, as shown in Figure 4.11.

For non-sharing applications, antennas may be shipped with all RETs assigned to AISG input port 1, as shown in the diagram on the left of Figure 4.11. Through reconfiguration at the site, specific RETs can be assigned to AISG input port 2 to allow a second AISG controller to have independent control through this separate connection.

Remote electrical tilt (RET)

The capacity to remotely adjust the aim of an antenna's beam to optimize its efficiency. RET uses actuators built into the antenna to adjust the beam up or down relative to the horizon.

Antenna Interface Standards Group (AISG)

AISG is composed of representatives from the world's leading wireless equipment manufacturers and service providers, including CommScope.

After an antenna sharing configuration has been completed, a specific RET can be controlled only through the AISG input port to which it is assigned. The diagrams shown in the middle and on the right show example configurations with the AISG input ports shaded the same color as the RETs that will be controlled.

To ensure equitable antenna sharing, the antenna's RET solution should work with the multipoint antenna involved and offer independent control for each operator through their BTS management software. It should also be scalable to accommodate network growth and the addition of more antennas.

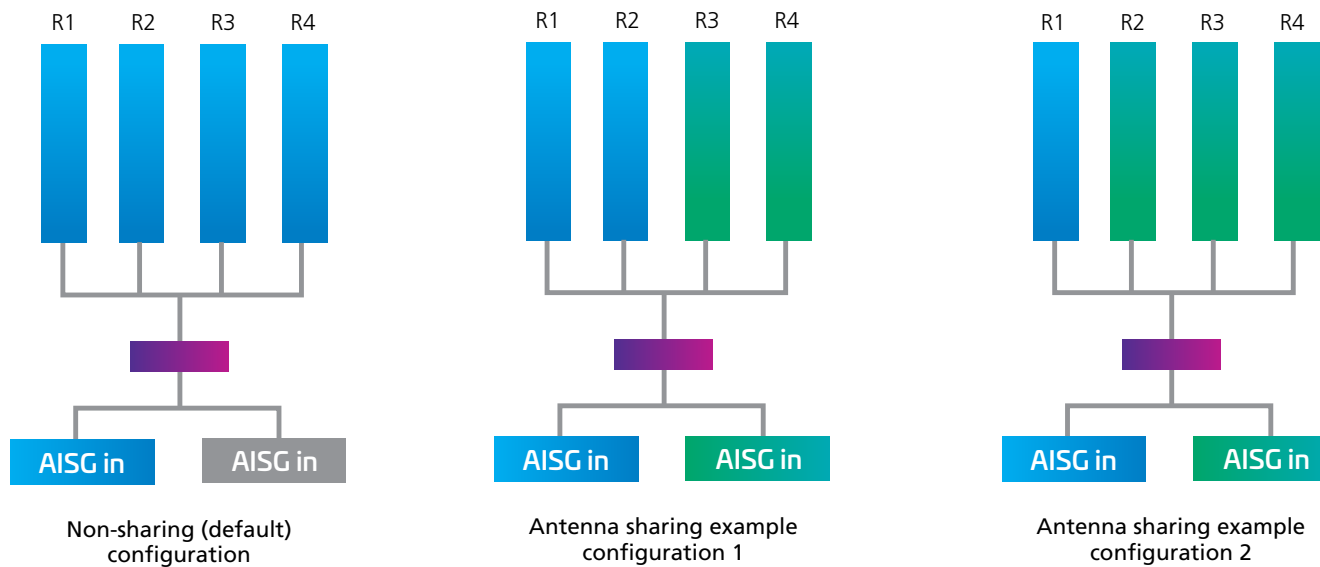

4.11: Various independent RET configurations

A closer look at active sharing

Active sharing is drawing a great deal of interest as a means of dealing with the high rollout costs of new and overlaid networks (such as 4G/LTE and 5G), as well as the constant need to conserve available spectrum. Operators are currently experimenting with several different active sharing arrangements involving various RF path components, spectrum assets and core network components.

Viewed as a continuum of complexity, one finds there is a clear tradeoff involved between efficiency and flexibility. Here are three examples of arrangements, arranged in increasing degrees of sharing, summarized in Figure 4.12 (on the following page):

- **Multi-operator RAN (MORAN)**

Here, only the RAN components of the RF path are shared; specifically, the base transceiver station (BTS), base station controller (BSC), node B and radio network controller (RNC) are split into multiple virtual radio access networks, each connected to the core network of the respective operator. Operators continue to use their own dedicated frequency bands.

- **Multi-operator core network (MOCN)**

As with MORAN, RAN components are shared while core networks remain separate. The difference here is the addition of spectrum pooling to the mix. It allows each cell in the shared RAN to broadcast all sharing operators' identities and other relevant information, including their NMO (network mode of operation) and common T3212 (location update timer). Participating operators in this arrangement tend to be similar in terms of market presence and spectrum assets in order to create an equitable arrangement.

- **Gateway core network (GWCN)**

This goes even further, sharing infrastructure, frequencies and core network elements such as the mobile switching center (MSC), serving GPRS support node (SGSN) and—in some cases—the mobility management entity (MME). This configuration enables the operators to realize additional cost savings compared to the MOCN model. However, it is a little less flexible and regulators may be concerned that it reduces the level of differentiation between operators.

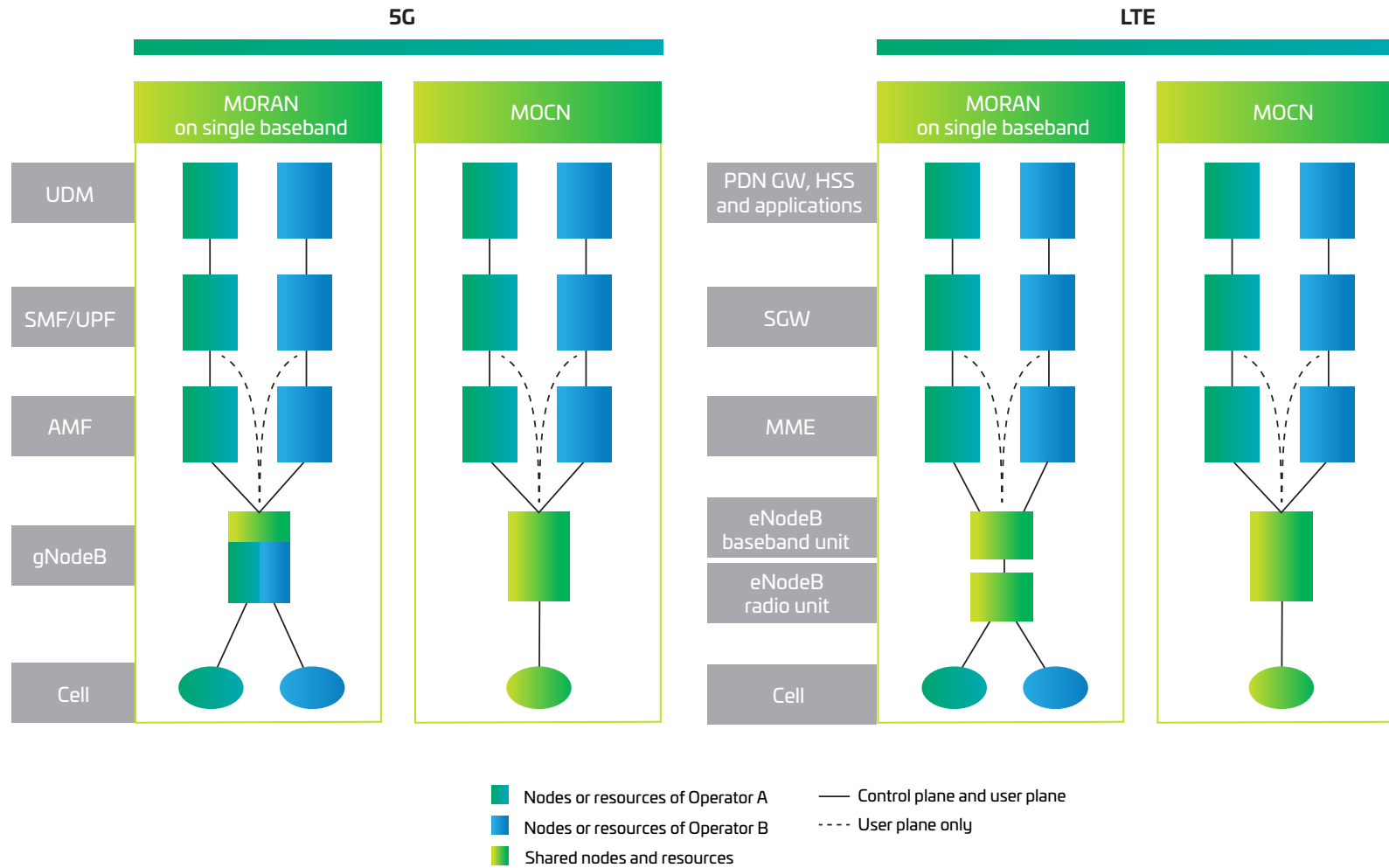

4.12: Active sharing models applicable to co-siting situations, showing increasing degrees of sharing

Making the most of available space and power

The design of a cellular communications system reflects many choices and compromises. The result is that no two deployments are exactly alike, and every decision is based on a unique balance of benefit and cost.

Co-siting is an advantage to many and a necessity for some; as global demand rises and available spaces disappear, co-siting will become more common all over the world. With the right strategy and solutions, the opportunity can outweigh the costs—ensuring better service for users and better efficiency for operators.

Chapter 4 summary

- Network sharing includes passive and active sharing, national roaming and antenna sharing practices.
- Co-siting allows more performance in less space.
- Co-siting strategy is driven by amount, weight and cost of base equipment and antenna-mounted equipment
- Multiband combining leverages feeder cable's capacity for multiple frequencies—with guard bands.
- Same-band combining includes hybrid combining (inexpensive but lossy) and low-loss combiners (efficient but with limited frequencies).
- Independent RET control makes antenna sharing more practical.



Chapter 5

Getting from the air to the network: Cables and connectivity

Look around your home and office and you'll see wires, cords and cables everywhere. In your office, network cables connect your computer to the outside world. In your living room, coaxial cables bring in premium programming and high-definition video cables feed it to your flat-screen TV. Even in homes that have replaced land lines with mobile phones, getting a strong mobile signal relies on the coaxial cables or optical fibers running up the nearest cell tower. These connections manage the flow of information that drives our daily lives. CommScope is dedicated to the continuous improvement of cable technologies that have an impact on every life, every day.

Whatever its composition or size, every cable performs the same simple functions: the reliable transmission of power or patterns of information (or both!) from a transmitter to a receiver. Even in a wireless network, this cabling—also known as a transmission line—plays an indispensable role, connecting the wired network to the wireless world, enabling you to communicate and share with people and devices around the world. Whether it's in a mobile

switching center, on a cell tower or connected to the modem inside your home, cabling is an indispensable part of the RF path.

Much more than power alone

Long ago, transmission lines were primarily used to provide electrical connectivity. Multi-conductor transmission lines could efficiently connect a power source (like a generator or battery) to a device that would consume that energy. This kind of simple circuit configuration is common even today; you use it every time you plug an electrical device into a wall socket.

The same idea was also used to bring telephone voice signals into the home and business. But telephone technology evolved and its limitations became more apparent. When passing multiple circuits along a single transmission line, the signals proved highly vulnerable to external interference that negatively affected call clarity.

To address this problem, Bell Telephone Laboratories developed a new type of cable in the 1930s. It was a shielded cable consisting of an inner conductor surrounded by nonconductive material called a "dielectric." This nonconductive material was then surrounded by an outer, sleeve-shaped conductor, and the whole assembly was finally encased in an insulating

Transmission line

The physical medium that conducts RF power from one point to another, usually between a base station and an antenna.

cover. This design may sound familiar to you, since it represents the first coaxial cable, which is little changed even today for data transmission (Figure 5.1).

In RF applications, coaxial cable is used as a transmission line for radio frequencies. One reason is something known as the “skin effect,” which happens when conducting an alternating current like an RF signal. When traveling through a coaxial cable, these types of signals ride along the outermost part of the solid inner conductor. The benefit of this arrangement is that it allows the outer surface of the outer conductor to be grounded.

Signals pass along a coaxial cable by riding the outer surface of the interior conductor—and the inner surface of the outer conductor—with a nonconductive dielectric layer between them. As a result, the only escape points for the energy carried on the line are at either end—exactly where they’re needed for clear transmission.

Coaxial cable

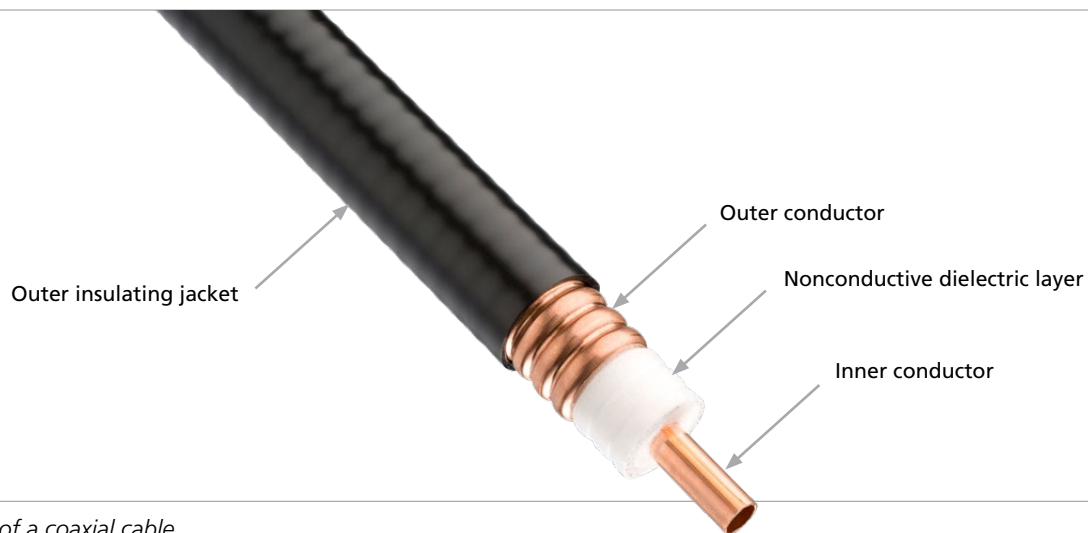

A transmission line built to prevent interference while carrying multiple signals. It consists of an inner core conductor and an outer sleeve conductor, separated by a nonconductive dielectric layer.



5.1: The basic construction of a coaxial cable

Coaxial cable types

Modern coaxial cables used in RF transmission can be grouped into three main categories: solid dielectric, air dielectric and foam dielectric. The construction of each category makes each of them suited to particular uses.

CABLE CROSS SECTION	CABLE TYPE	ADVANTAGES	DISADVANTAGES
	<p>Solid dielectric cables employ a flexible inner conductor (stranded or woven, as opposed to a solid wire), covered by solid extruded polyethylene insulation. The outer conductor is braided, and multiple layers can be stacked with shielding foil between them. The outer insulation is a polyethylene jacket.</p>	<ul style="list-style-type: none"> • Flexible • Easy to install • Inexpensive • No pressurization required 	<ul style="list-style-type: none"> • High signal loss • Prone to deterioration • RF signal leakage through outer conductor
	<p>Air dielectric cables are similar to the solid variety except that they employ open space as the inner nonconductive layer. This cavity is supported with small insulating spacers that maintain the open channel and are pressurized to keep out moisture.</p>	<ul style="list-style-type: none"> • Low signal loss • High power and frequency capacity • Long operational life 	<ul style="list-style-type: none"> • High initial costs • Pressurization logistics • Vulnerability to moisture
	<p>Foam dielectric cables employ a solid (as opposed to stranded) copper wire core. The outer conductor is generally smooth aluminum, corrugated aluminum or corrugated copper. The inner nonconductive layer is made of polymer foam, which combines several key advantages from both solid and air dielectric cable varieties. Its power loss and cost characteristics lay between the two other options, but foam also offers practical advantages that make it the preferred choice in many modern two-way RF applications.</p>	<ul style="list-style-type: none"> • Reduced power loss • No pressurization required • Moderately priced • Long operational life • Enhanced crush resistance 	<ul style="list-style-type: none"> • Slightly more loss than air dielectric • More expensive than solid dielectric

The mechanical elements of coaxial cable

Several material choices are available for both the conductive and nonconductive elements of coaxial cable. The specific needs of a particular use determine which combination is most efficient and affordable. Figure 5.2 shows one of the many variants available.

Signal energy is carried along the inner and outer conductor. You will notice that, in both cases, the surface area of the outer conductor is much greater than that of the inner conductor. Therefore, the conductive properties of the inner conductor must be as efficient as possible. That's why highly conductive copper is almost universally preferred.

Braided copper is the most commonly used outer conductor on solid dielectric cables. It offers conductivity and its braided design improves its flexibility. Solid copper or aluminum material, either corrugated or smooth-walled, is most often used for foam or air dielectric cables. The choice between aluminum and copper often comes down to cost; aluminum is less expensive than copper but it also has lower conductivity.

Polyethylene is the preferred dielectric material for RF transmission because of its low loss characteristics and long life span. It can be used in either solid or foam dielectric constructions, or as the spacers in an air

dielectric design. For high-power applications with higher operating temperatures, Teflon® may be substituted because of its high melting point. The tradeoff is that Teflon is more expensive. Lower cost alternative materials are available, which offer temperature resistances between those of polyethylene and Teflon.

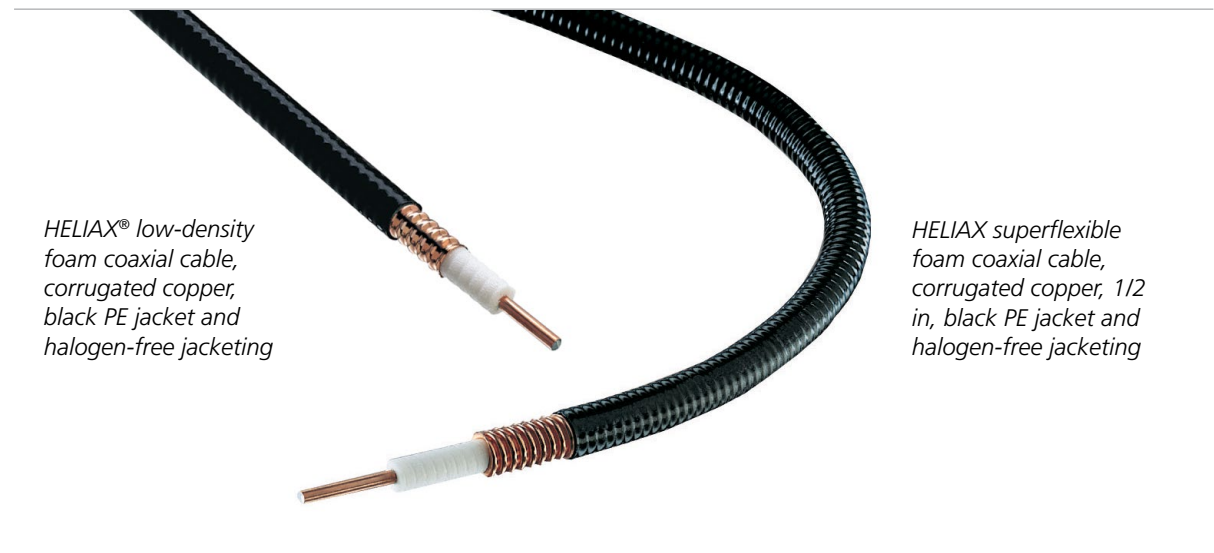

5.2: Corrugated copper coaxial cables

Electrical properties of coaxial cable

Signal loss, or attenuation, is a significant consideration in the design of a cable. The loss occurs in three ways:

- 1. Conductor loss:** Signal loss that occurs due to the conductive properties of the cable's materials.
- 2. RF leakage:** Loss of signal through a cable's shielding.
- 3. Insulation loss:** A fixed degree of attenuation caused by the cable's dielectric layer.

Attenuation in transmission lines is expressed in decibels per 100 feet (or meters) of cable length.

How well these losses are managed depends on such factors as the size and length of the cable, the conductivity of the cable materials, the frequencies traveling along the cable and the effectiveness of its shielding. There are general physical rules governing how these factors impact attenuation, such as:

Cable size. As a rule, a cable's conductor loss will decrease as its size increases. The larger the cable's cross section, the more conductive area is available.

Cable design. Solid outer conductors allow less RF leakage than braided ones, though at the expense of flexibility.

Dielectric material choice. Each dielectric material exhibits a predictable level of insulation loss. As explained

earlier, air dielectric offers the lowest insulation loss, while solid dielectric comes with the highest loss.

Assigned frequency. All three types of attenuation directly increase as a function of the frequency of the cable's signal. The higher the frequency and the shorter the wavelength, the greater the loss in any given cable.

This complex balancing act of performance, ease of handling, and cost means no single transmission line design is ideal for all, or even most, circumstances. Each application demands its own unique compromise between these factors.

Another compounding factor that is becoming more urgent is the environmental impact of higher attenuation, in all its forms. Signal loss weakens the overall RF gain, and that loss needs to be compensated for if your coverage and capacity are to be met. Typically, that involves turning up the power on the radio. Over time, running radios at these higher power levels puts more pressure on the power grid and compounds the resulting environmental impacts.

Characteristic impedance

Characteristic impedance, commonly called "cable impedance," is a measurement of the electrical resistance of an RF transmission line as measured in ohms. The figure is derived by a complex formula involving the ratio

Attenuation

Measured in decibels (dB), this is the loss of power experienced by an RF signal as it moves from one point to another. Transmission line attenuation is expressed in either decibels per 100 feet (dB/100 ft) or meters (dB/100 m) of cable length.

Ohm

The unit of electrical resistance, or impedance. In terms of RF transmission lines, ohms refer to the inherent, or characteristic, loss over a length of cable.

between the cable's two conductors. As a general rule the industry standard impedance for RF cable is usually 50 ohms (though some applications require 75 ohms).

The expected degree of impedance can be affected by imperfections or damage in the cable itself. For example, a deep dent in the outer wall of a coaxial cable can cause its impedance to vary from its standard level. This disruption is called a "discontinuity," or a change in the distance between the inner and outer conductors, as you might see from a squashed cable. The signal reflects within the cable, creating the same loss of performance as a mismatch between cable and antenna (Chapter 3).

This is one reason a cable's flexibility and crush resistance are such crucial factors—damage during installation is a frequent source of discontinuity and can be expensive and time-consuming to remedy.

Velocity of propagation

The velocity of propagation within a coaxial cable is the speed at which a signal can travel along that cable. Velocity is governed by the amount and type of dielectric used; it is expressed as a percentage of the speed of light, from 67% for solid dielectric cables up to 92% for air dielectric cables. Since the speed of light is more than 670 million miles per hour, velocity is rarely a concern. However, there are exceptions when velocity becomes relevant, such as when phasing is required.

Power handling capability

The amount of power a transmission line can handle depends on the ambient temperature and the operating temperature of the cable.

As we've seen, power loss is inherent in any cable design and depends on the kind of dielectric used in the line. This power loss takes the form of heat; the greater the attenuation within a cable, the more heat it will generate from that lost energy. Likewise, the greater the frequency passing along any given cable, the more heat it will generate as a function of loss.

Heat resistance is a critical factor in cable design. For instance, foam dielectrics begin to soften near 180 degrees Fahrenheit. Ensuring the combined internal and ambient temperatures won't exceed 180 degrees is critical in selecting the right type of transmission line. If the cable exceeds this limit, the softened dielectric will allow the inner conductor to shift, creating a discontinuity. If it should contact the outer conductor, the result would be a shorted cable. To help engineers make the right choice and prevent such failures, cable manufacturers like CommScope rate each type of cable for certain power levels at certain ambient temperatures.

RF leakage

As its name suggests, RF leakage is a function of the physical ways an RF signal can “leak” out of a transmission line. In the case of a cable with a braided outer conductor, there are countless tiny openings in the cable. As with a leaky garden hose, the more power (or pressure) you apply, the more significantly those leaks affect performance.

In addition to attenuation, RF leakage causes another challenge when several high-power braided coaxial cables are arrayed in close proximity to each other. The leakage can create interference between the cables at their endpoints. Common points of leakage include antenna connections, multi-couplers and duplexers (see Chapter 7 for more information). Faulty connections can make this problem worse.

As with power handling, RF leakage is included in a cable’s specifications to help engineers choose the best option for a particular configuration—especially where many cables terminate close together.

Cable life expectancy

The expected useful life span of a coaxial transmission line depends largely upon environmental factors. Since engineers have little control over these factors, they must compensate by choosing the right design with the right materials to assure the longest possible life span.

The composition of the cable’s outer jacket is one of the more obvious considerations. Most flexible and semi-flexible coaxial line jackets use polyethylene, polypropylene, or polyvinyl chloride (PVC). All three options are vulnerable to long-term sun exposure, so manufacturers incorporate carbon black into the resin to improve the jacket’s resistance to aging under ultraviolet light, which can extend their operational lives. This improvement is the reason coaxial cable used in most applications is black—particularly outdoors.

Moisture and humidity are important factors as well. While water can infiltrate through tiny nicks, cuts or age cracks in the cable, the most common form of moisture infiltration is through improperly sealed connectors on the ends of the cable. Even humid air inside the connector can condense as temperatures fall, resulting in liquid water that wicks deeper into the cable along the outer conductor’s braid. This can potentially corrupt the entire cable and short the inner and outer conductors—

Environmental factors

The climate and setting of a cable installation dictates what kind of cable should be used. Considerations include:

- Sunlight UV exposure
- Humidity and moisture
- Temperature extremes

Passive intermodulation (PIM)

PIM is interference that occurs at a system’s non-linear points—such as junctions, connections or interfaces between dissimilar metal conductors—creating interfering frequencies that can decrease efficiency. The higher the signal amplitude, or power, the greater the effect.

particularly in the connectors themselves. The result is increased signal reflections within the cable and degraded performance due to passive intermodulation (PIM).

Longer lasting cables = greener networks

In 2021, CommScope conducted life-cycle assessments (LCAs) on all our copper cable products. An LCA quantifies the total environmental effects of the cable, from the extraction of the raw materials to its use in operation and the end of its usable life.

By developing longer lasting, less impactful products, we are able to extend the purchasing cycle and reduce the environmental strain of frequent production cycles.

Through initiatives like our ReelSmart® recycling program in which we pick up and recycle used CommScope (broadband) cable reels, we help customers further reduce waste.

Overall, in 2021, CommScope successfully eliminated 87.8% of nonhazardous waste from landfills.



Coaxial connectors

The high costs of PIM make connector technology a critical part of efficient connectivity, since connectors are one of the most common sources of this crippling interference. As the number of modern RF applications has grown, the technology used to connect a cable to its terminus has evolved. The simple designs created in the 1940s for military uses have diversified and improved into a variety of types (Figures 5.3 through 5.11 on next page).

UHF connectors are the oldest and most popular type still in use for two-way communications. They are rugged, reliable and easy to install, which is why they are the preferred choice for applications with frequencies up to 300 MHz.

Quality connectors combat climate change

Transportation is the largest contributor to climate change in the U.S., according to the EPA, accounting for around 28% of greenhouse gas (GHG) emissions. With thousands of truck rolls per network each year, mobile operators are in a prime position to help reduce GHG emissions and help stem the tide of climate change.

PIM and moisture buildup are two of the most common reasons for poor performing networks. In both cases, the root problem can often be traced to faulty or poorly installed connectors.

Making sure you're using quality RF connectors and installing them properly, the first time, can make a significant difference in reducing the number of truck rolls and your network's carbon footprint.



BNC connectors are small and feature a bayonet-style lock coupling that makes it easy to disconnect. BNCs are often used on narrow cables connecting equipment.

TNC connectors are similar to BNC connectors but include threaded connections that keep them secure in environments where vibration is a concern.

Type-N connectors are an industry favorite for RF applications with frequencies above 300 MHz, where UHF connectors are not suitable. Type-N connectors may be rated to perform at 10 GHz or even higher.

EIA flanges are primarily used on pressurized air dielectric cables operating above 450 MHz. These connectors offer the standard 50 ohms of impedance and typically offer higher voltage characteristics than Type-N connectors.

DIN (Deutsche Industrie Normenausschuss) connectors are available in several sizes and have been a preferred connector due to its large cross section, which is greater than that offered by Type-N connectors. However, due to increasing PIM concerns and higher connection densities on antennas and other RF equipment, DIN is giving way to the newer 4.3-10, Nex10, and 2.2-5 connector types.

4.3-10 and other new small form factor connectors like Nex10 and 2.2-5 are quickly becoming the industry standard RF connector for 4G/5G and small cell networks because of their ability to mitigate PIM interference.

<p>5.3: 4.3-10 connectors, the newest industry standard</p> 	<p>5.4: DIN coaxial connector</p> 	<p>5.5: Type N connector</p> 
<p>5.6: BNC coaxial connector</p> 	<p>5.7: TNC coaxial connector</p> 	<p>5.8: EIA flange coaxial connector</p> 
<p>5.9: NEX10 coaxial connector</p> 	<p>5.10: 2.2-5 coaxial connector</p> 	<p>5.11: Ganged connector</p> 

They feature a radial contact and low coupling torque requirements, making it easier to ensure a proper installation and solid contact. The separation of their mechanical and electrical planes offers superior PIM characteristics compared to DIN equivalents, and their smaller footprint allows for more connections in crowded interfaces—a very useful benefit for more sophisticated multiport antennas being used today.

Installation step 1: Cable choice

When it comes to the practical process of planning a cable deployment, we've shown that there are many variables that must be anticipated and balanced for the best result. As discussed above, choosing an appropriate cable depends on knowing:

- The frequencies it must carry
- How much loss is tolerable
- The environment where it will be installed
- What kind of budget limits exist

In most cases, there will be more than one acceptable cable solution for any one of these four criteria, but the key is to get the greatest possible balance of benefits among all four factors. In the real world, the best decision may be based on dollars as much as wattage.

For instance, while smaller-diameter cables may cost less to purchase and install, they may need more upkeep

and eventual replacement. We may also consider a less expensive option with a higher rate of loss. If we can compensate for the loss with greater RF power generation on one end or increased antenna gain on the other, this may be a good solution.

Installation step 2: Field testing

Once you have selected and installed the cable that best performs to your application's priorities, the process of fine-tuning that performance can begin. There are three tests you would likely perform: inner and outer conductor continuity, shorts between conductors, and a voltage standing wave ratio (VSWR) test.

The first two tests are simple and direct measurements of impedance in the cable, performed with an ohmmeter. Any physical disruption of the cable's integrity would show up as a nonstandard level of impedance. You would then begin inspecting the cable for the source of the problem.

The third test (VSWR) is an indirect but ultimately more revealing measurement of overall line performance. Basically, the VSWR test measures the amount of signal reflection within the cable. Measuring both forward and reflected power with a wattmeter, you can compare the values against the cable manufacturer's conversion chart for that particular type of cable. If everything is functioning correctly, the observed amount of reflected

energy should fall within expected limits. Poorly made connections or connections with mismatched impedance will quickly become obvious. This process is explained in more detail in Chapter 3.

Installation step 3: Troubleshooting

Reduced RF communication performance can be rooted in any number of problems and occur in any component in the system. When the antenna and transmitter have been ruled out as potential trouble spots, it's time to examine the transmission lines—because a lot of things can go wrong with cables.

Here are just a few things that can impact transmission line performance and cause network efficiency to drop suddenly:

Weather. A bad storm, lightning, hail or high winds can damage cables and loosen connectors. Visit the site and speak to those familiar with recent weather trends.

Local phenomena. In addition to weather, other local events can impact performance. Explosions from nearby mining operations, small earthquakes, and even a stray bullet from a hunter's gun have been identified as culprits. To get a better understanding of the extent to which the site is subject to such phenomena, speak with the local maintenance engineering team.

Water infiltration. As discussed earlier, water is perhaps a cable's greatest enemy. Checking connectors for signs of moisture, double-checking their seals, and examining the cable itself for any new damage will help confirm whether water is a cause.

Whatever the cause of the performance drop, if damage is identified in a transmission line, it cannot be repaired or taped. It must be replaced completely. Long-term system performance degradation without an obvious proximate cause can be just as serious. A common culprit is cable aging. While metal-sheath cables are almost impervious to aging when properly installed, inferior cables can age and crack with extended exposure to the sun's UV rays and extreme temperatures.

Localizing the problem

If your VSWR measurements reveal a high level of reflection—say, 20% above the level indicated by the manufacturer's table—the cable likely is experiencing an open, a short or a partial short somewhere along its length or in a connector.

To confirm this, you could perform the following tests:

- Open the top of the cable, remove the cable ground, and short the inner and outer conductors. Measure impedance between the conductors with an ohmmeter. An intact cable will show low impedance between the

two, while high impedance will reveal damage to the outer conductor. This kind of damage is hard to locate. If economically feasible, replacement may be the best option.

- Remove the short between the conductors and test impedance again. In this instance, an intact cable will show high impedance, while low impedance may indicate damage to the inner conductor that creates a short somewhere within the cable. The damage required to cause this kind of fault often leaves more obvious traces on the outer jacket and is easier to identify.
- Examine the connectors themselves. Type-N connectors (and, to a lesser extent, DIN connectors) are particularly vulnerable to misalignment and pin breakage, which can result in a short. Also, as the primary source for any potential water infiltration, it's a good idea to examine all connectors for signs of moisture. For best results, check connectors during cool weather or at night, where any trapped vapor will have condensed into more visible droplets. As mentioned above, the new 4.3-10 connector type is designed to avoid installation errors and incorrect torque applications, making it less vulnerable to these kinds of problems.
- Practice good preventative maintenance. Proper installations reduce the need for ongoing maintenance, but vigilance is always to your benefit. Any time an

installation is realigned or painted, it's smart to inspect the cables and connectors. Identifying small problems before they become big problems can save a great deal of time and money and minimize lost performance.

In summary, a solid understanding of the construction of cables helps you understand their best applications, where they may be vulnerable, and where to look when a fault is suspected.

Fiber-optic cable in the RF path

The role of fiber-optic cable at cell sites is growing quickly. It is steadily displacing copper coaxial cable, as it can provide faster speeds, greater bandwidth and increased electrical efficiency. This is particularly true where sites have adopted remote architectures, placing radios, amplifiers and other components on top of the tower near the antennas, as we will see shortly.

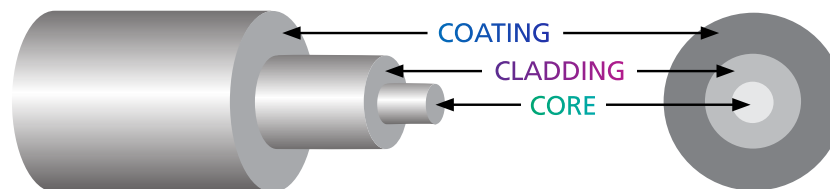

5.12: The structure of a simple fiber-optic cable

The structure of a fiber-optic cable is simple. It consists of a light-conducting glass core surrounded by cladding and a protective coating (Figure 5.12). Signals propagate through fiber-optic cable as serial light pulses rather than electrical patterns used in copper cabling.

Because fiber-optic cable uses light pulses instead of changing electrical currents, it is much more energy efficient than copper cable and generates no internal heat. Signals also propagate at virtually the speed of light, making it faster than copper; by using multiple wavelengths (colors) of light, many signals can be sent simultaneously without creating interference with each other—increasing available bandwidth.

However, fiber-optic cable must be handled differently than coaxial cable, and installers new to fiber will need training on how to properly install it. All fiber-optic cable specifies a maximum bend radius—a measure of how sharp a turn it can make before the core is subject to damage. In crowded deployments, it's possible to accidentally exceed this limit, damage the cable and cause optical power loss.

Fiber-to-the-antenna (FTTA)

One of the fastest growing fiber optic applications is fiber-to-the-antenna (FTTA). FTTA is an extremely

efficient way to move network traffic from the tower-mounted components down to the base station at the bottom of the tower. FTTA cabling runs up the tower from the enclosure at the bottom. Once on the tower, the cabling can be broken out to connect one or more remote radios and antennas.

The fiber-optic cable below can be installed either as separate runs or as a single trunk with a breakout system that feeds fiber to the radios. Additionally, hybrid (fiber and power) cable is gaining popularity in some regions. Bundling fiber and power in a single cable or assembly, hybrid cabling helps accelerate installation. Breakout system options for FTFA deployments may include a junction box, plug-and-play assemblies or other structures. Figure 5.13 below shows an example of individual fibers joined into a single multifiber cable running down to the base station. The antenna connects to the radio via a short RF jumper.

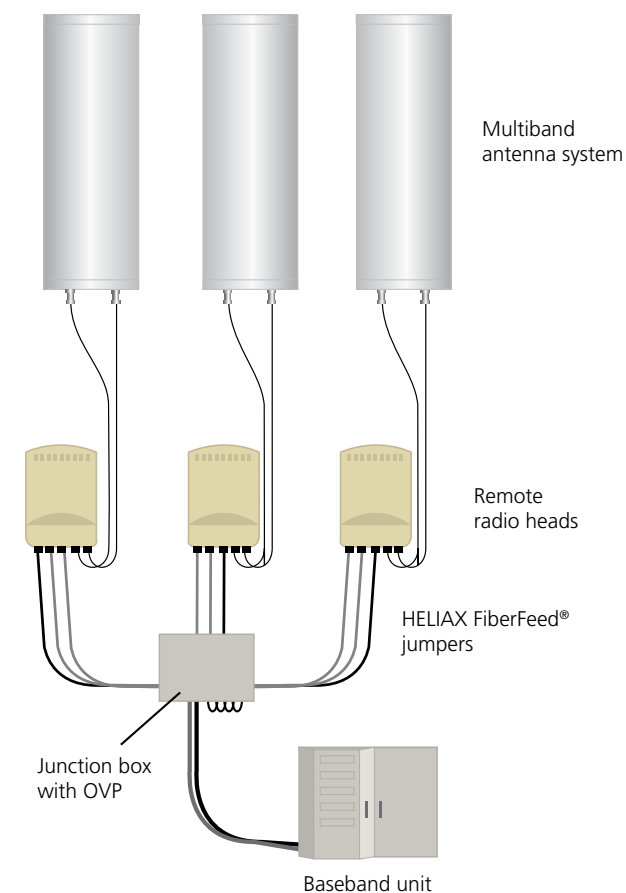

5.13: An example of the structure of an FTFA deployment, with copper cable between antennas and radios, and radios linked by fiber-optic feed cables to the base station on the ground

Hybrid cable

Since fiber-optic cable uses light, not electricity, to propagate signals, it cannot be used to power remote radios. A power cable must be added; this can be done by adding a separate power cable alongside the fiber, or through a hybrid cable that contains both power and fiber under a single sheath. A cutaway illustration of this construction can be seen in Figure 5.14.

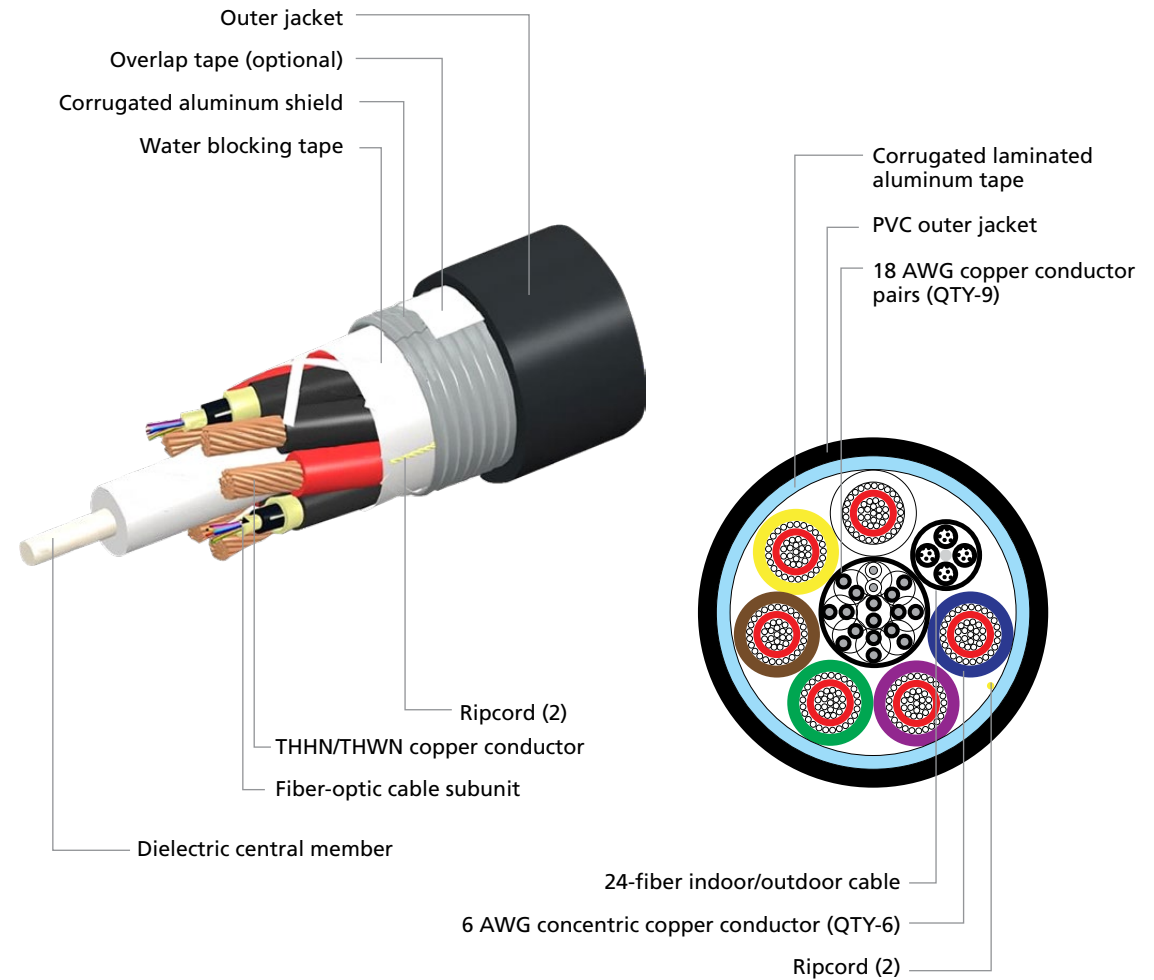

Hybrid deployments are now the preferred method for new and upgraded sites for a number of technological, logistical and economic reasons. Chief among these are:

- It is slimmer and lighter than two discrete cable runs, reducing tower weight and wind load.
- It is available in multiple architectures designed to support a range of FTTA site configurations (see Figure 5.15 on next page).
- It reduces the complexity of site infrastructure and reduces SKU count for operators.
- It is quicker to deploy than discrete runs.
- It offers the fiber bandwidth operators need for current and future network capacity needs.
- It reduces the amount of material used in production and the associated environmental impacts.



5.14: The internal structure of a hybrid cable

There are several ways hybrid cable can break out to components at the top of the tower, depending on the operator's needs and the number of radios involved. Some of these configurations are shown in Figure 5.15.

<p>HELIAX® Discrete</p> <p>Separate fiber and power cables run from shelter/cabinet to tower-top equipment.</p>	<p>HELIAX Modular with optional SkyBlox™</p> <p>Modular fiber, power or hybrid trunk with optional SkyBlox plug-and-play breakout.</p>	<p>HELIAX Trunk-to-breakout box</p> <p>Hybrid fiber/power trunk terminates at the breakout box.</p>
		
<p>Applications</p>		
<p>Tower, rooftop and small cell deployments requiring design flexibility and lower initial cost. Highly customizable with familiar installation process.</p>	<p>Installations requiring customizable and accelerated deployment, top-of-tower space efficiency and frequent equipment upgrades.</p>	<p>Excellent balance of deployment speed, flexible design and upgradability; one trunk supports up to eight RRUs and/or antennas.</p>
<p>Features and benefits</p>		
<p>Reduce cost and time:</p> <ul style="list-style-type: none"> • Cables precut to length reduces material cost, speeds ground prep <p>Customize solution:</p> <ul style="list-style-type: none"> • More connector options, best-fit solution <p>Flexible upgrades:</p> <ul style="list-style-type: none"> • Enables a pay-as-you-grow approach 	<p>Reduce cost and time:</p> <ul style="list-style-type: none"> • Modular preconnectorized/preconfigured design requires less time and only one installer <p>Future ready:</p> <ul style="list-style-type: none"> • 6:1 fiber-to-conductor ratio; works with SkyBlox plug-and-play and stackable breakout module and trunk-to-breakout box <p>Sustainable design:</p> <ul style="list-style-type: none"> • Less SKUs reduces package waste; SkyBlox is the first 100% recyclable breakout box; add network capabilities without replacing the trunk 	<p>Faster installation:</p> <ul style="list-style-type: none"> • Only one cable to prep and pull, one installer <p>Future ready:</p> <ul style="list-style-type: none"> • Single, lighter trunk lets you add more equipment without overloading the tower; add/replace jumpers to upgrade capabilities • Moderate labor intensity <p>Sustainable design:</p> <ul style="list-style-type: none"> • Streamlined design minimizes packaging, production, transportation and materials use

5.15: Examples of FTTA configurations using various breakout methods to bring hybrid cable's data and power connectivity to the tower top

Optical and hybrid cable assemblies

As Figure 5.16 shows, FTTA installations can be accomplished by running only one or two trunk cables up the tower, with some examples supporting a dozen or more individual radios at once. Splicing or connectorizing fiber-optic cable is much more demanding than it is for copper, and much less forgiving of imperfections. Even a speck of dust trapped inside an optical connection can cripple a cable's throughput.

To simplify the work done in the field, CommScope manufactures cable assemblies for fiber-optic and hybrid cable applications (Figure 5.16). These ensure factory quality, less work required on-site, and reduce the likelihood of installer error, which would otherwise necessitate a return trip up the tower.

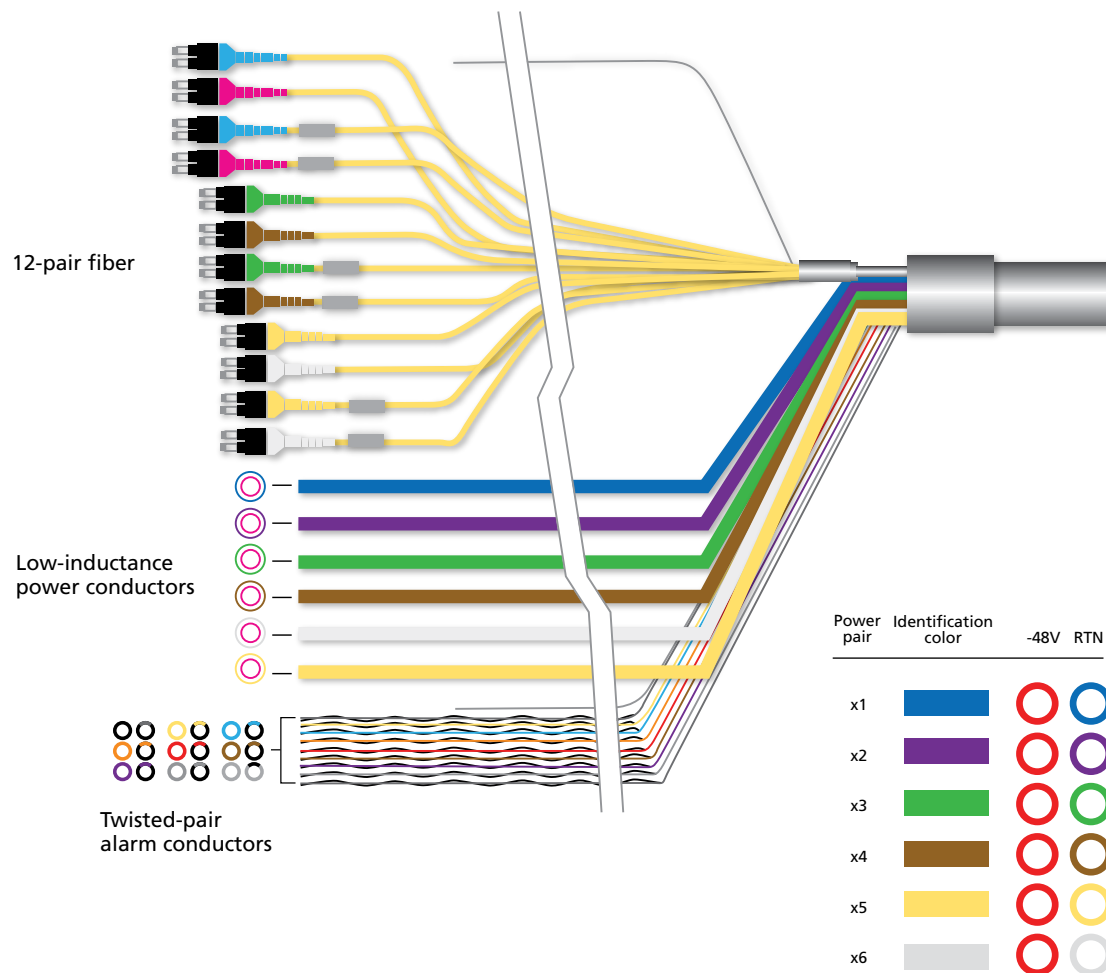

5.16: A hybrid cable assembly for a six-radio installation, featuring 12 pairs of fiber-optic cable, six power cables and a host of alarm-conducting wires

Fiber-optic and hybrid connectors

Connectors are also an important part of fiber-optic infrastructure—particularly in FTTA deployments.

Connectors are often located outdoors, so they must be rugged enough to withstand the elements without allowing any deflection of the optical signal. Because there are so many ways fiber-optic and hybrid cable can be used at a site—and such a variety of architectures and RF components—there is a wide variety of connector types (Figure 5.17). These include:

- LC connectors—duplex uniboot for 2 mm, 3 mm, 3.6 mm, 5 mm, 5.4 mm, and 6 mm OD subunit
- Radial outdoor ruggedized connector (ODC style two to four fibers)
- OVDA outdoor connector with LC duplex interface
- Outdoor ruggedized MPO connector (12 and 24 fibers)
- Standard MPO connectors (12 and 24 fibers)
- SC/APC and SC/PC connectors
- Hybrid connector (power/fiber with LC interface)
- HMFOC 2-12 fiber connections
- Hardened SCAPC connectors
- LC simplex and duplex connectors (900 um, 2 mm and 3 mm subunits)



5.17: Some of the many different kinds of fiber-optic and hybrid cable connectors currently available

Fiber-optic enclosures

Connectors are not the only way to connect or break out fiber-optic cable. Fiber enclosures can be located almost anywhere on the tower or at the base and allow the neat and orderly connection and/or breakout of fiber-optic cable. Enclosures provide a compact,

weatherproof package that can also include storage for extra cable, eliminating the need for additional cutting and termination (Figure 5.18). Power cabling can also be interconnected through these boxes, with optional over-voltage protection (OVP).



5.18: Different kinds of fiber-optic enclosures that weatherproof complex cable breakouts

Other fiber-optic cable accessories

Because of the special handling requirements of fiber-optic and hybrid cable, there exists a broad ecosystem of accessories designed to make installations simpler, quicker and less prone to mistakes (Figure 5.19). These accessories include:

1. Hangers designed to meet the specified hang distances allowed by the manufacturer
2. Hoisting grips to allow safe, damage-free cable handling
3. Grounding kits that prevent electrical damage

4. Management shelves for fiber optic patching
5. MPO cassettes that provide easy connectivity
6. Fiber plug-and-play box offering a 6RRU solution in convenient storage box
7. Fiber management device securely stores up to 5 meters of excess 7 mm fiber cable

There are many other related accessories and parts. As the use of fiber-optic infrastructure increases at cell sites, this ecosystem of solutions is also sure to grow.

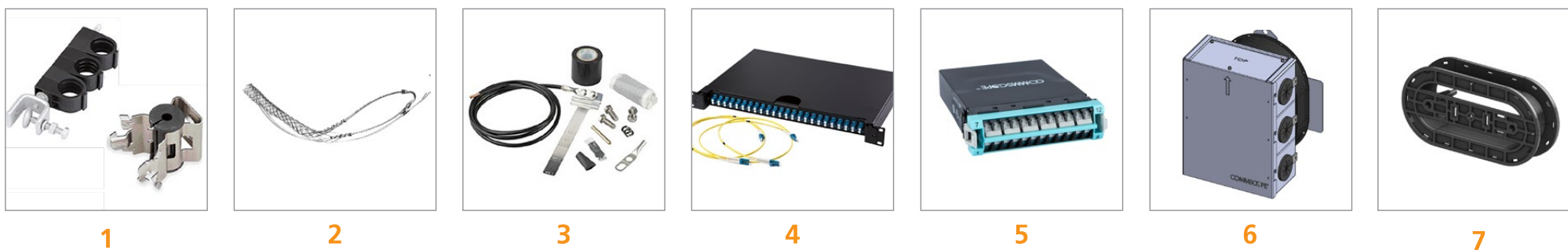

5.19: Some of the accessories used to support fiber-optic infrastructure

**PIM has nowhere left to hide:
PIM-Guard® accessories**

As MNO macro networks grow more complex and crowded, the risk of PIM (passive intermodulation) grows as well.

A major cause of PIM is loose or corroded metal connections that are in imperfect contact with each other or the tower. Metallic non-RF path accessories like brackets, hangers and mounts are some of the most common culprits. As more RF-path components are added to the tower, the PIM risks from these accessories increase. That’s why CommScope developed PIM-Guard.

The PIM-Guard family includes a full range of cable support brackets, hangers, RRU mounts, roof mounts, cable bands, cable ties and tower adapters. From materials selection and corrosion resistance to the exterior contours and profile, PIM-Guard components are optimized to reduce PIM while maximizing structural integrity.

When combined with CommScope’s PIM-fighting RF path components, PIM-Guard accessories provide an end-to-end strategy that enables network contractors and installers to improve the RF efficiency in their customers’ evolving and complex networks.

PIM-Guard accessories:

PIM-Guard components are optimized to reduce PIM while maximizing structural integrity.
[Learn more here.](#)

PIM mitigation installer best practice

Replace metal cable installation hardware with CommScope’s PIM-Guard solutions.

Avoid metal as much as possible, especially metal-to-metal junctions.

Ensure high contact force between components.

Keep cable routing and management neat and clean.

Use polymer cable hangers, tower adapters, snap-in hanger isolators

Always follow manufacturer’s installation torque values, using calibrated tools.

Remove any unused hardware and materials from tower and site.

Tighten all nuts and bolts.



1



2



3

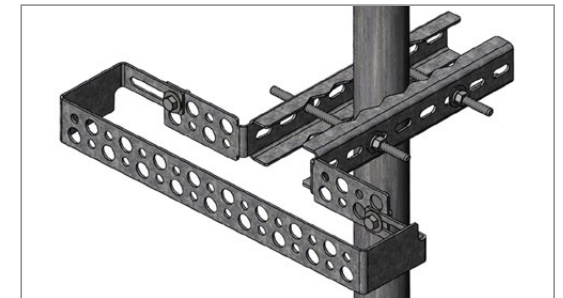

4

Communication depends on connectivity

While so much of modern RF communication is composed of radio energy radiated through the air, the critical links on either end depend on having the right kind of transmission line cable and the right connectors between base station and antenna. This connectivity is what binds thousands of cell towers into a network that can instantly connect two users on opposite sides of the globe.

As a physical link, these cables must be able to flex where they're needed, withstand the punishing elements, and faithfully carry the frequencies that eventually reach you as your internet connection, land-line call, or mobile phone call virtually anywhere in the world.

The same type of connected ecosystem exists in your home, only on a smaller scale. From the USB cord on your computer mouse to the century-old design of your telephone's wall cord, each cable is designed to carry specific frequencies over specific lengths.

As a leading provider of coaxial and fiber-optic products for networks all over the world, CommScope is at the forefront of the race to develop innovative solutions that will push the limits of speed, capacity and efficiency in RF networks.

Chapter 5 summary

RF transmission lines:

- The bridge between base station and antenna
- Adapted from designs once used just to carry electricity

Coaxial cable:

- Characterized by insulated inner and outer conductors
 - Solid dielectric
 - Air dielectric
 - Foam dielectric

Mechanics and materials:

- Copper used for inner conductor
- Copper or aluminum used for outer conductor
- Polyethylene used for dielectric insulation
- 4.3-10 connector is the emerging standard for its superior PIM performance and small footprint

Fiber cable:

- Fiber-optic cable is seeing increasing use in cell sites
- Hybrid cable adds a power line to the fiber optics
- FTTA connects radios and base stations with increased bandwidth, speed and efficiency
- Fiber-optic cable is delicate and requires its own mounting and interface solutions

Accessories:

PIM-Guard components are optimized to reduce PIM while maximizing structural integrity.

Chapter 6

The impact of PIM on mobile networks

Passive intermodulation (PIM) has been a major source of performance degradation in mobile networks for years. As mobile networks grow more complex, the risk and damage of PIM continue to increase. As a result, network operators and their RF path solution vendors must invest more time and dollars to test, certify, identify and remove potential sources of PIM from their networks and products.

With PIM on the rise, much has been written about the mathematics and theory behind it; therefore, we will not spend time in this chapter on the background of PIM. Instead, this chapter focuses on:

- Impact and types of PIM
- PIM testing: component-level vs. network-level approaches
- Product designs for excellent PIM performance
- Site troubleshooting to overcome PIM

PIM: Public enemy #1 for uplink performance

PIM is a source of unwanted interference in mobile networks. It attacks the network's most vulnerable spot: the uplink path, used to transmit data from the user equipment (UE) back to the serving cell site.

As in any communication link, interference degrades the distance at which the link can operate at a low bit or block error rate. Thus, PIM not only degrades the coverage of the mobile network; it also impacts several underlying network performance key performance indicators (KPIs), such as uplink throughput, dropped call rates, handover failures, network accessibility and others. In other words, PIM can significantly impact the quality of the user experience.



Learn more about PIM theory

For more on the background and theory of PIM, we recommend the white paper: [Analysis and simulation of broadband and cross-band PIM in base station antennas](#)

Intra-band vs. crossband PIM

PIM can be generated in many ways. One of the most common scenarios is when a high-power transmission signal interacts with an object that behaves in a nonlinear manner, like a low-pressure contact junction between two metal objects, corroded or rusty metallic objects, or a poor-quality solder joint. This interaction can result in the generation of two different types of PIM:

- **Intra-band PIM** occurs when combinations of two or more signals are transmitted in the same band on a common physical path through an RF device like a coaxial cable, filter, or antenna
- **Crossband PIM** is created when two or more signals in different bands are transmitted on different paths that converge on an object with nonlinear behavior (as described above).

In trying to eliminate these potential PIM sources, vendors of RF transmission path products typically focus on mitigating intra-band PIM (multiband combiners, which are designed to combine separate bands into a common path, are one notable exception). Use of PIM-certified products helps reduce intra-band PIM, although cell sites can still be impacted by intra-band PIM if poor installation practices are followed (such as improperly torqued connectors, poor connector cleanliness, and metallic

components or structures in the field of view of the antennas).

Crossband PIM is much more difficult to isolate and control than intra-band PIM. It is generated from signal interactions across multiple frequency bands, including high-power RF signals that interact with objects that are external to the cell site equipment. The extraordinarily high number of scenarios that would need to be re-created in the lab makes crossband PIM testing extremely difficult during product manufacturing.

To help visualize PIM interactions, CommScope developed a **3D PIM Calculator** that not only calculates frequency ranges for PIM interactions, based on transmit signal definition and combinations, but also estimates PIM levels—enabling the user to understand the severity of a particular scenario on network performance.

Modeling intra-band PIM

In Figure 6.1, the 3D PIM Calculator models an intra-band PIM scenario involving two 30-watt (W) carriers in the PCS band (3GPP Band 25). The carriers occupy blocks B3 and G in Band 25; as they are transmitted through the antenna, they combine to create third- and fifth-order PIM responses that degrade the sensitivity of the G-block (uplink) receiver by 5.9 decibels (dB). This alerts the network designer to the risk of combining B3 and G block carriers on the same RF path.

A second intra-band PIM scenario is shown in Figure 6.2. Here, two carriers are generated from a dual-band radio—one carrier in Band 12 and one in Band 14. This is considered an intra-band PIM scenario because the antenna connected to the radio supports both bands on a given port. The modeled results from the 3D PIM Calculator indicate that this carrier combination results in a significant desense of the uplink channels for both carriers.

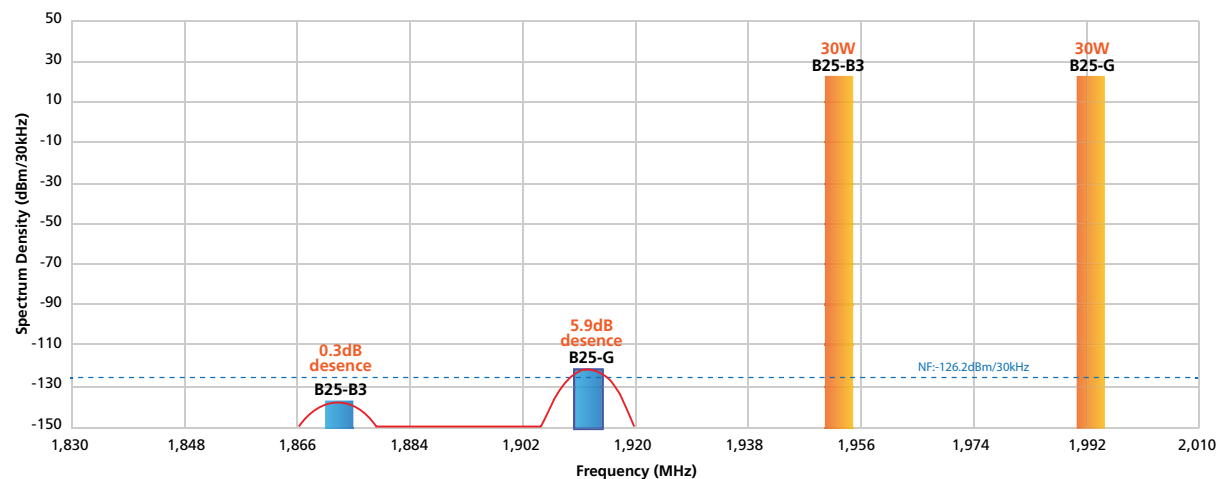

6.1: Intra-band PIM modeling using multiple carriers on the PCS band (3GPP Band 25)

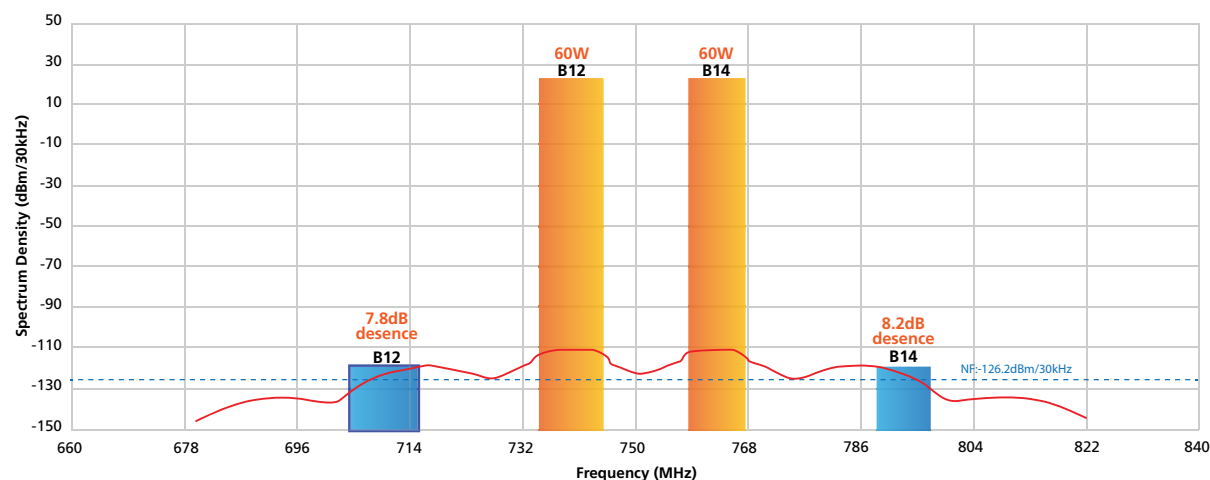

6.2: Intra-band PIM scenario involving dual-band radio

Modeling crossband PIM

Figure 6.3 presents a crossband PIM scenario that may be familiar to many North American operators; it involves one group of carriers in the PCS band (Band 25) and a second group in the AWS band (Band 66). The spacing between the two carrier groups causes a third-order PIM interaction that falls in the Band 66 uplink blocks, near 1739 MHz. Even if these two carrier groups are transmitting on separate antenna arrays, a PIM object (external to the site) can generate this level of passive interference and degrade Band 66 uplink performance.

Component-level vs network-level testing

Component-level PIM testing

The increasing impact of PIM on mobile networks has led most operators to demand that, before deploying any RF path product, it must undergo PIM testing as part of the manufacturing process. Most vendors now conduct this testing on 100% of products shipped. The PIM testing methodology used by RF component vendors was standardized under IEC 62037 to ensure that a common test approach is used across the industry. The standardized methodology utilizes two 20 W CW test tones that are designed to stimulate a third-order

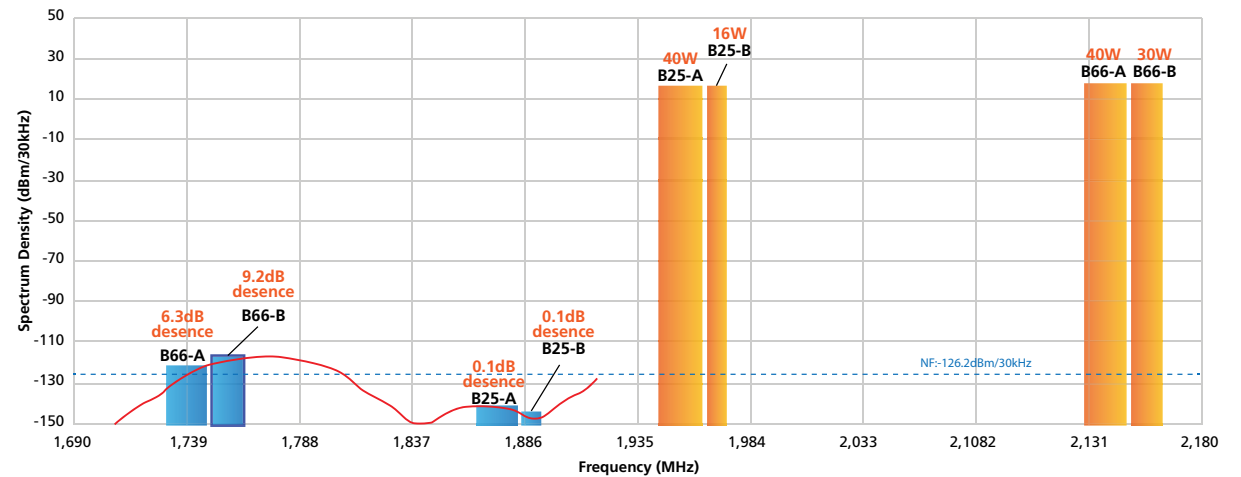

6.3: Crossband PIM example; PCS and AWS carriers

PIM response. The test tones can be generated at fixed frequencies or swept across a specified frequency band. For swept frequency testing, one tone is held at a fixed frequency while the second tone is swept; fixed and swept tones are typically alternated during the test. Additionally, the unit under test is subjected to a vibration profile during the test to expose any manufacturing defects associated with the product's assembly or poor soldering processes.

Product specifications for PIM use the IEC 62037 standard; the PIM level is expressed as a minimum dBc value (relative level referenced to a defined carrier power level) and assumes 2x20 W or 2x43 dBm test tones. For example, a PIM spec value of -150 dBc is equivalent to an absolute level of $-150 + 43$ or -107 dBm; the measured PIM response across the specified band cannot exceed this value.

Figure 6.4 shows the results of a failed test performed on an antenna using standard PIM equipment. The test was run on the antenna's low band (700 MHz) port using a fixed tone test. Many outdoor tests opt for fixed tone testing (vs swept testing) to avoid corrupting the test with external interference or user traffic. The maximum response of the port measured in the plot below was -134.6 dBc (-91.6 dBm)—well above the -150 dBc specification.

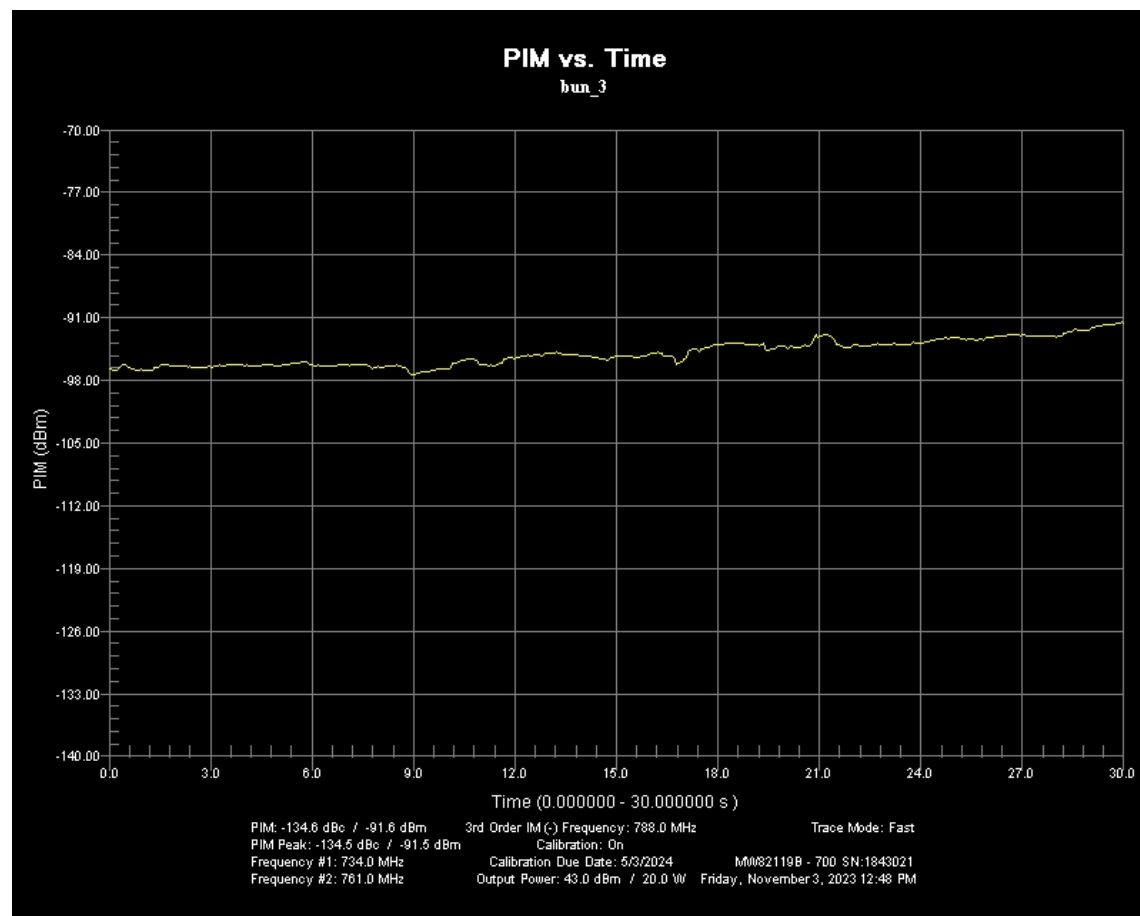

6.4: Example of a failed component-level, fixed-tone PIM test

Many mobile operators today are foregoing component-level PIM testing by site construction teams prior to product installation. Instead, they are relying more on the vendor's factory testing to ensure in-spec PIM performance while charging the construction team with site quality assurance. So, what happens if PIM issues are detected on site, once product installation is complete? This is where network-level testing comes into play.

Network-level PIM testing

In network-level testing, operators typically employ various Operations Support System (OSS) features to simulate site activity and collect data to verify if the site is being impacted by PIM. These OSS features—such as Air Interface Load Generator and Orthogonal Channel Noise Simulation—simulate maximum traffic levels on one or more bands, forcing the assigned radios to transmit at maximum power. The receive bands of one or more radios are then monitored to see if the uplink noise floor is degraded enough to indicate a PIM issue.

Figure 6.5 shows an example of a network-level test in which no PIM issues were detected. The red “square waves,” indicating the percentage of traffic loading on a particular carrier or set of carriers, show when maximum traffic levels were turned on and off for several cycles. The test measured uplink channel levels across all four of the radio's receive ports. Readings in the -118 to -119 dBm range are considered good levels; this range is the noise

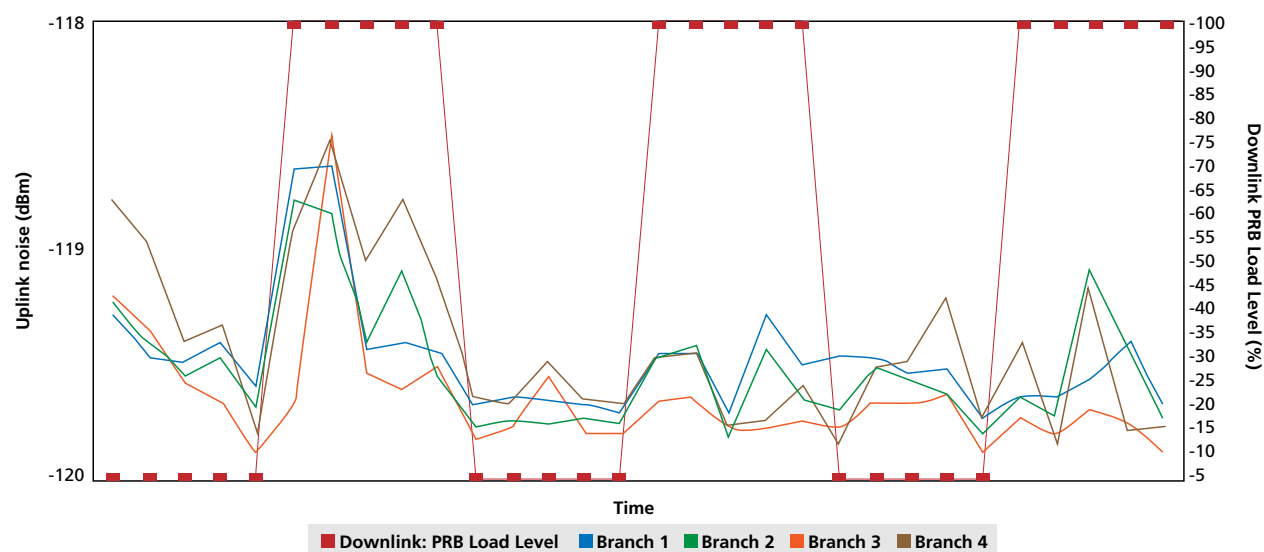

6.5: Example of a passing network-level PIM/uplink test

floor of the radio in a 180 kHz bandwidth—the size of one resource block.

While network-level testing can validate site uplink performance, it does not replace component-level PIM testing as a means to verify whether a single component, like an antenna or RF jumper, is defective.

One reason for this is that the two test methods utilize vastly different test simulation levels and signal types. A failed network-level test does not necessarily mean the product's PIM performance is out of spec. Remember, component-level testing uses a standard two-tone test at 20 W per tone. Network testing, however, uses up to four modulated high-power radio outputs, each utilizing orthogonal frequency domain modulation (OFDM) generated from hundreds of individual subcarrier tones.

A second commonly used network-level testing approach substitutes the uplink measurements collected through the OSS with direct measurements from the fronthaul common public radio interface (CPRI) channels between the radio and the baseband unit. The data collected is similar to that shown in Figure 6.5; the major difference is the amount of time required to receive the test results. Using data from the CPRI fronthaul provides results in near-real time, while waiting for an OSS-generated report takes time.

CommScope is committed to working closely with customers to better understand the correlation between network-level test results and component-level test results. The goal is to diagnose under-performing components more quickly and effectively and eliminate them from the network.

Designing products for excellent PIM performance

Base station antennas

CommScope's base station antennas are designed to ensure excellent PIM performance throughout their operational life. PIM performance is a key focus that impacts every step of the design process: component-level electrical design, mechanical design, assembly and product qualification. Our technical expertise—the product of decades of practical experience—has led to the development of design rules and process controls that are now industry standards. Among these is a high level of process automation that enables us and our customers to achieve a superior level of PIM control.

Additionally, CommScope has developed innovative techniques to make our antenna products less susceptible to environmental PIM. They include automated testing

using our proprietary PIM 3D Heatmap to provide a three-dimensional visualization of an antenna's PIM susceptibility. Figure 6.6 compares conventional PIM susceptibility testing and the CommScope PIM 3D Heatmap approach.

Traditional PIM Susceptibility Test

Traditional test method is putting an external PIM source at fixed locations of antenna back side and measure antenna in band PIM directly to check the sensitivity of antenna to environment PIM.

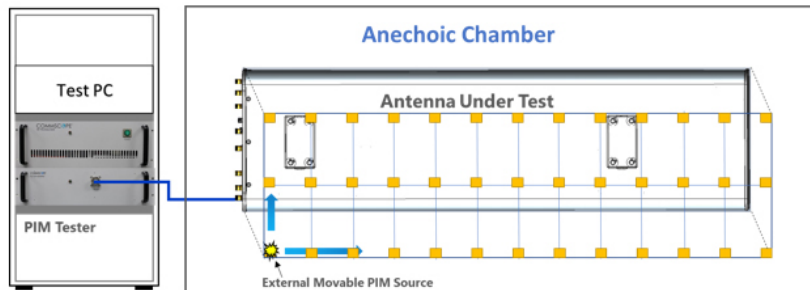

Limitations

- Low test efficiency and low data sampling (resolution).
- Frequency range and band is limited by PIM test instruments.
- External PIM source level is hard to control (hard to reproduce same test data on a different bench).
- Results may be corrupted by internal PIM in the antenna.

CommScope PIM Susceptibility Test

CommScope developed an efficient test method which can test the PIM susceptibility in wide band frequency with high speed and high resolutions.

Data visualization (heatmap) is applied to make antenna PIM susceptibility performance display more straightforward and easy for analysis.

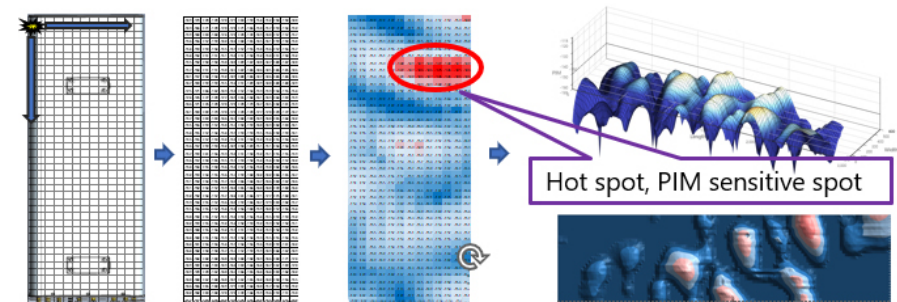

Advantages

- Data visualization
- High test efficiency with high data sampling
- Full frequency bands
- Be able to get the PIM sensitivity of different environment PIM levels
- Not impacted by antenna internal PIM

6.6: Conventional PIM susceptibility testing (left) vs PIM susceptibility testing with CommScope's 3D Heatmap (right)

Figure 6.7 further illustrates the benefit of using the 3D PIM Heatmap technology during the antenna design process to make the final product more immune to external PIM.

One example to show how the visualization of PIM susceptibility performance guide the new platform design

With the heatmap to visualize the PIM susceptibility performance, it's more efficiency and straightforward to guide our antenna design. Below two heatmap shows the PIM susceptibility performance improvement when CommScope implement different design concept to make the antenna more immune during new platform design. Booth concepts work well for pattern, return loss, isolation, but different PIM immunity per the heatmap test.

Design Concept 1

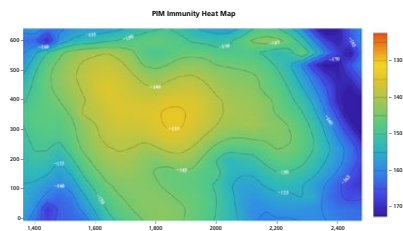

Design Concept 2

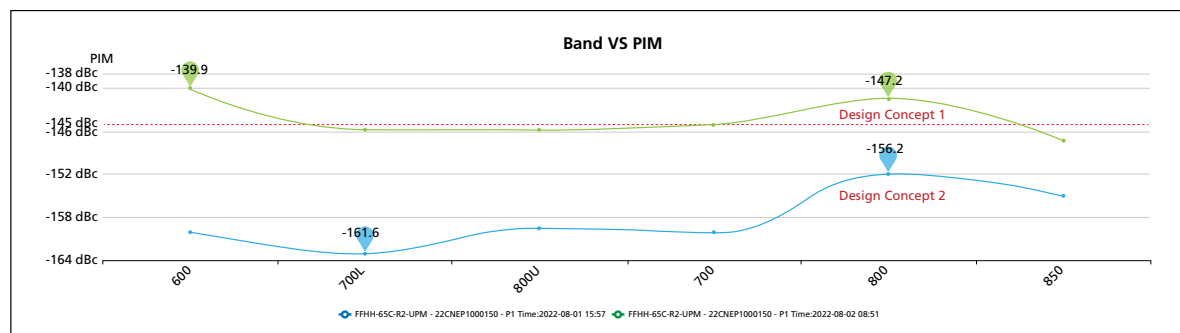
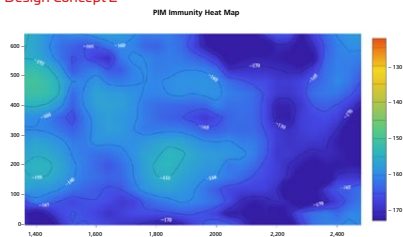

6.7: PIM Heatmap use for design optimization

RF conditioning products

When designing RF conditioning products for excellent PIM performance, it is important to recognize and develop techniques and processes to avoid the most common sources of PIM:

- Areas where non-symmetric current flow is created: This includes junctions or sharp edges where current density can rise to very high levels, making them prone to corona discharge and micro-arcing. Poor, cracked or cold solder joints, or loose mechanical junctions can also create high non-symmetric current flow.
- Non-conducting substances, like dirt or oxidation, on surfaces where current flow is present
- Metallic particles that may cause locally high fields
- Poor/contaminated plating, or poor plating design
- Ferromagnetic material, like fixing screws, in critical areas

To mitigate PIM risk, CommScope focuses on three main areas:

- **Predictive design:** Using electromagnetic and mechanical simulation data, CommScope has developed a customized PIM predictor simulation tool that helps our engineers identify critical areas during the design phase, including feature geometry, contact pressure, and the number, spacing, and torque of fixing screws used in the assembly of the product.

- **Material quality:** Quality materials ensure the right surface finish and correct plating layers and thickness are used.
- **Process control:** This ensures the correct solder joint quality and component cleanliness to eliminate fingerprints or dust contamination during assembly and tuning.

All finished RF conditioning products are tested under dynamic conditions, as shown in the example below in Figure 6.8.



6.8: RF conditioning products undergoing dynamic PIM testing

RF coaxial jumpers

Coaxial cable has been used for decades to provide connectivity between radio transceivers and antennas in mobile networks. PIM requirements have had a significant impact on the way these coaxial products are designed, manufactured, and tested. Achieving excellent PIM performance requires focusing on key areas within the coaxial jumpers and assemblies. They include connector selection, connector attachment technology, weatherproofing, process control, and test methodology.

CommScope's patented Sureflex® cabling shows how paying careful attention to these elements can improve PIM performance. Its design focuses on excellent physical bonding between the cable and connector—guaranteeing overall cable assembly performance and offering superior protection against environmental degradation.



REUSABLE



PROTECTION



PREVENTION

HELIAX® cable and matching Sureflex connectors are specifically engineered to be used together—optimizing RF performance and extending long-term reliability.

Important characteristics of the Sureflex process include:

- **Automated cable preparation:** In a factory-controlled environment, the jacket is removed from the cable end, and specialized machinery cleans the cable surface and preps the cable for connector attachment.
- **Solder connection:** A 360-degree, lead-free solder joint is used to physically bind the connector to the cable on the inner and outer contact surfaces using a continuous bead of solder. This prevents water ingress and degradation of performance due to tower vibration.
- **Pin depth:** The depth of the center conductor is carefully monitored in real time to ensure consistent voltage standing wave ratio (VSWR) and PIM performance.

CommScope's SureGuard® weather protection boots are added to the finished jumper assembly to provide superior long-term protection of the connector attachment to the radio or antenna equipment.

The finished Sureflex jumpers are 100% tested for PIM performance under dynamic conditions.



6.9: Sureflex cable assemblies with integrated SureGuard weather protection

PIM-Guard accessories

During LTE deployment, mobile operators quickly learned the importance of good PIM hygiene when mounting and attaching the equipment, antennas, and cabling that connects all the RAN elements. The main focus of PIM hygiene is to remove low contact-pressure, metal-to-metal junctions in and around the antenna and radio equipment. To address this challenge, CommScope introduced the

PIM-Guard family of accessories, which are manufactured largely from non-metallic polymer materials. Accessories that continued to incorporate metal were redesigned where necessary to ensure they cannot generate PIM. The result is a robust and flexible series of accessory products that help operators minimize the impact of PIM on their sites.



6.10: SnapTak™ polymer hangers and adapters

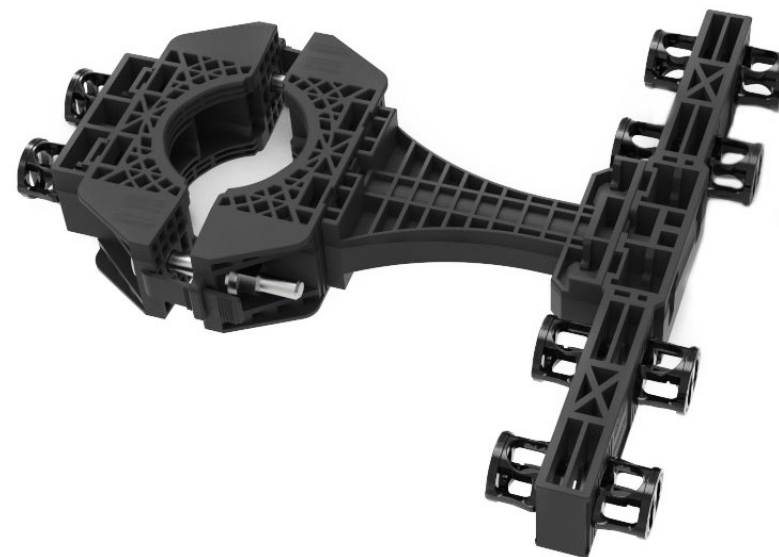

6.11: PIM-Guard cable support bracket

Structural steel solutions

Antenna mounts play a critical role in the overall integrity of a cell site—connecting the antenna to the supporting structure, such as a tower or rooftop. However, inadequate antenna mounts can introduce or exacerbate PIM-related problems. Here are some key considerations regarding antenna mounts and their impact on PIM:

Material selection: Choosing the right materials for antenna mounts is vital. The materials should possess excellent electrical conductivity, corrosion resistance and mechanical stability. Galvanized steel or other suitable metals are commonly used to ensure a reliable and durable connection, minimizing the risk of PIM due to material degradation or contact resistance.

Mechanical integrity: Antenna mounts should be structurally robust to withstand environmental conditions, including wind, temperature fluctuations and vibrations. Any movement or flexing in the mount due to inadequate mechanical integrity can create intermittent contacts or metal-to-metal interactions that contribute to PIM.

Rigorous testing and validation: CommScope subjects sector frames to comprehensive testing and validation to ensure these products meet the highest standards for performance, reliability and PIM mitigation.

Site troubleshooting to overcome PIM

When diagnosing PIM issues in the field, it is important to understand whether the PIM is being generated within the site or is coming from an external source. Resolving external PIM issues can be very difficult and costly as they can be hard to isolate and their impact can change dynamically over time.

Getting to the bottom of an on-site PIM issue is often easier. If an RF path component is suspected to be the root cause, it should be removed from the site and tested using calibrated PIM gear, according to the industry-standard two-tone, 2x20 W test process previously defined. However, removing the suspect component isn't always practical, as this requires a service interruption.

Instead, the common practice over the past several years has been to utilize network-level testing to try and isolate the PIM. Once identified, the site is taken off-line as the offending component is replaced. The network-level testing approach was discussed earlier in this chapter (reference Figure 6.5).

RF path vs external PIM

One way to isolate whether a PIM source is within the RF path or external to the site is to look at the uplink noise floor across all receive branches (typically, either two or four, depending on whether the radio configuration is 2T2R or 4T4R). Monitoring the uplink noise floor can be

done either through the OSS or by using a CPRI analyzer connected to the fronthaul fiber connection of the radio of interest.

If the PIM is found to be internal to the RF path, one of the RF branches will generally be impacted more than the others. You can also look for correlation between a high noise level on the branch and a high traffic level that is turned on for the carrier of interest (e.g., as during the peak portions of the square wave plot shown in Figure 6.5).

A second method for isolating external vs. internal PIM is to place an RF absorbing blanket over the aperture of the impacted antenna* Once the RF blanket is in place, enable the high-traffic simulation and observe the uplink noise floor of the receive branches. If the high noise level on one or more branches persists, then the PIM issue is likely occurring within the RF path. Use additional troubleshooting to further isolate the bad component.

If the uplink noise levels improve significantly, then the PIM source is likely external to the RF path. In that case, a tool like a spectrum analyzer with a PIM probe can be used to isolate an out-of-spec component. As noted earlier, identifying a PIM source external to the RF path can be time consuming and expensive; PIM levels can change over time, making the task even more difficult.

*Take care to limit the time that the radio is energized during testing, per the manufacturer's instructions.

Chapter 6 summary

Passive intermodulation (PIM) has been a major source of performance degradation in mobile networks for years. It attacks networks in a variety of ways: intra-band PIM and crossband PIM—PIM generated inside the RF path and outside of it.

New modeling technologies and techniques like CommScope's PIM 3D Heatmap and 3D PIM Calculator enable OEMs and MNOs to better anticipate and mitigate PIM issues.

PIM exists at the component level and the network level; OEMs take responsibility for controlling component-level PIM while MNOs focus on network-level PIM.

Controlling component-level PIM involves analyzing every step of the design process—electrical design, mechanical design, assembly and product qualification—as well as predictive analysis, material quality and process control.

To drive out PIM from its HELIAX SureFlex coaxial cables, assemblies, jumpers and connectors, CommScope focuses on automated cable prep, solder connections and pin depths.

CommScope's specially engineered antenna mounts and PIM-Guard polymer adapters, hangers and cable support brackets help eliminate PIM issues on and around the antenna and radios.

Isolating network-level PIM—especially if it is external to the site—can be difficult and time consuming.

One way to tell if PIM is internal or external is to look at the uplink noise floor across all receive branches. A second method is to use an RF absorbing blanket placed over the aperture of the impacted antenna.

Chapter 7

Spectrum management: Getting the most from every cycle

Of all the materials that go into creating a wireless network, the rarest and most precious isn't the copper in the transmission lines, the fiber optics in the backhaul or even the land where cell sites are located. In fact, it's not a material at all—it's spectrum: the "air" that networks breathe.

Spectrum is, by nature, a limited resource. You can't manufacture more of it simply because demand has increased, or because more wireless operators have entered the market. Most available spectrum is already assigned and in use all over the planet, and regulatory releases of additional spectrum are few and far between—and can also be very expensive.

Therefore, wireless network operators everywhere have a deep and vested interest in managing the spectrum they have in order to provide the best wireless service and experience to their customers.

Spectrum

The electromagnetic (EM) radiation covering particular frequencies. As it relates to wireless systems or devices, spectrum is the range of radio frequencies used by devices to communicate.

NTIA spectrum allocation chart showing spectrum allocations from 1 KHz to 300 GHz

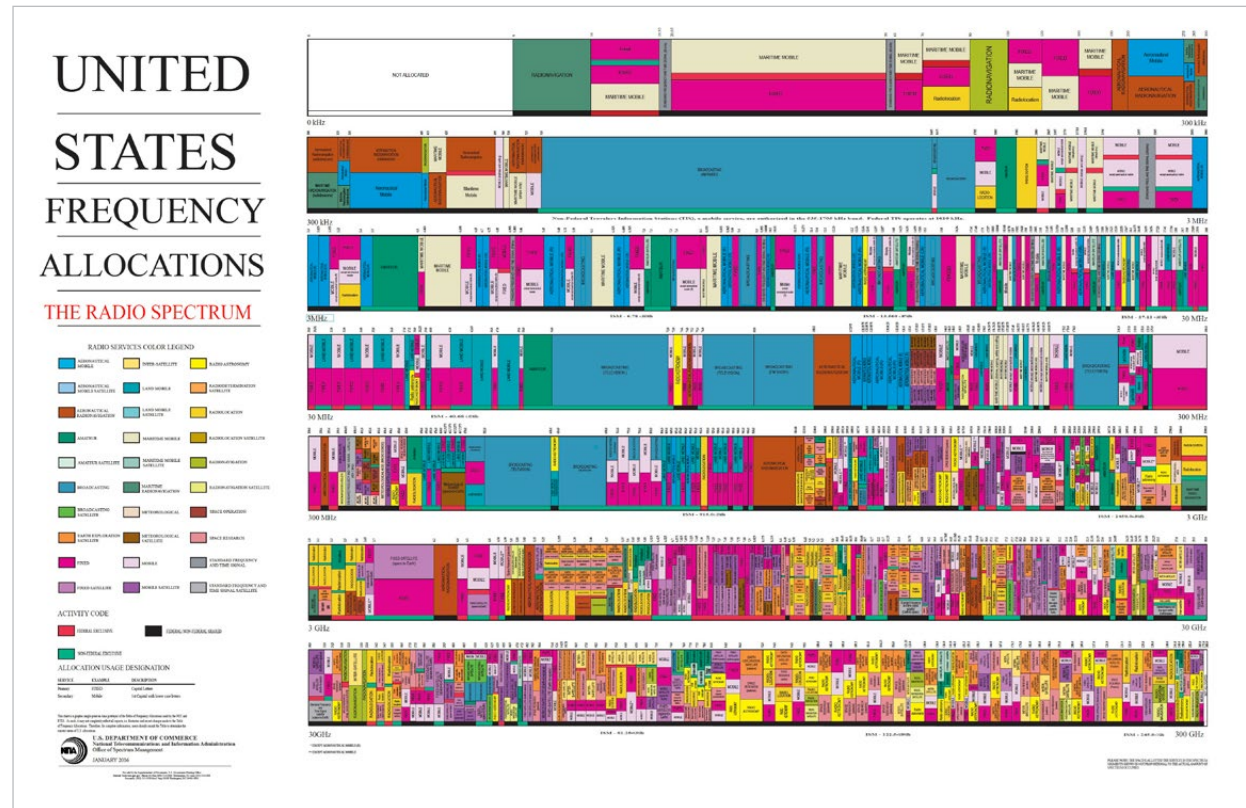

What does the RF spectrum look like?

All radios, including those used for wireless communications, rely on the availability of specific frequencies to operate. For this reason, the licensing of spectrum—from operator to operator, and area to area—is strictly regulated to prevent radios from interfering with one another. So what does the spectrum look like? Radio frequencies include a wide range of the EM spectrum, as you can see in Figure 7.1.

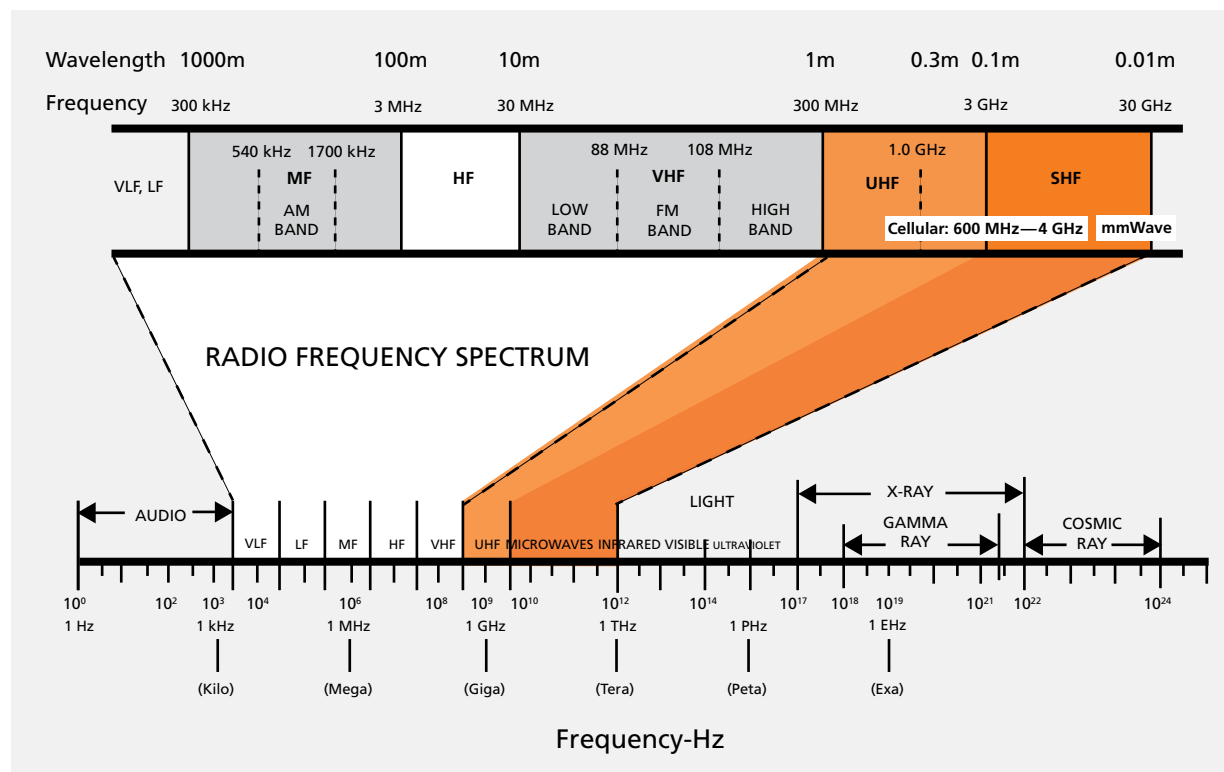

7.1: RF frequencies within the electromagnetic (EM) spectrum

Getting licensed spectrum

To secure the legal right to use parts of the RF spectrum in a particular market, the wireless operator must acquire the relevant license. This can be done several ways. One way is to apply to the Federal Communications Commission (FCC) for a license to use specific frequencies—for example, licensing for microwave backhaul. Another way to acquire spectrum is to participate in a spectrum auction managed by the regulating government agency. In the United States, that agency is the FCC. Other countries have their own regulatory agencies.

Because spectrum is a finite resource in an age of skyrocketing demand, the winning bids for such auctions can range in the hundreds of millions to billions of dollars. In auctions that ended in February 2021, the FCC netted a record-breaking \$81 billion for the 3.7 GHz band covering 3700 to 3980 MHz. This total was composed of 21 bidders winning 5,684 licenses overall. AT&T's spectrum acquired is shown in Figure 7.2.

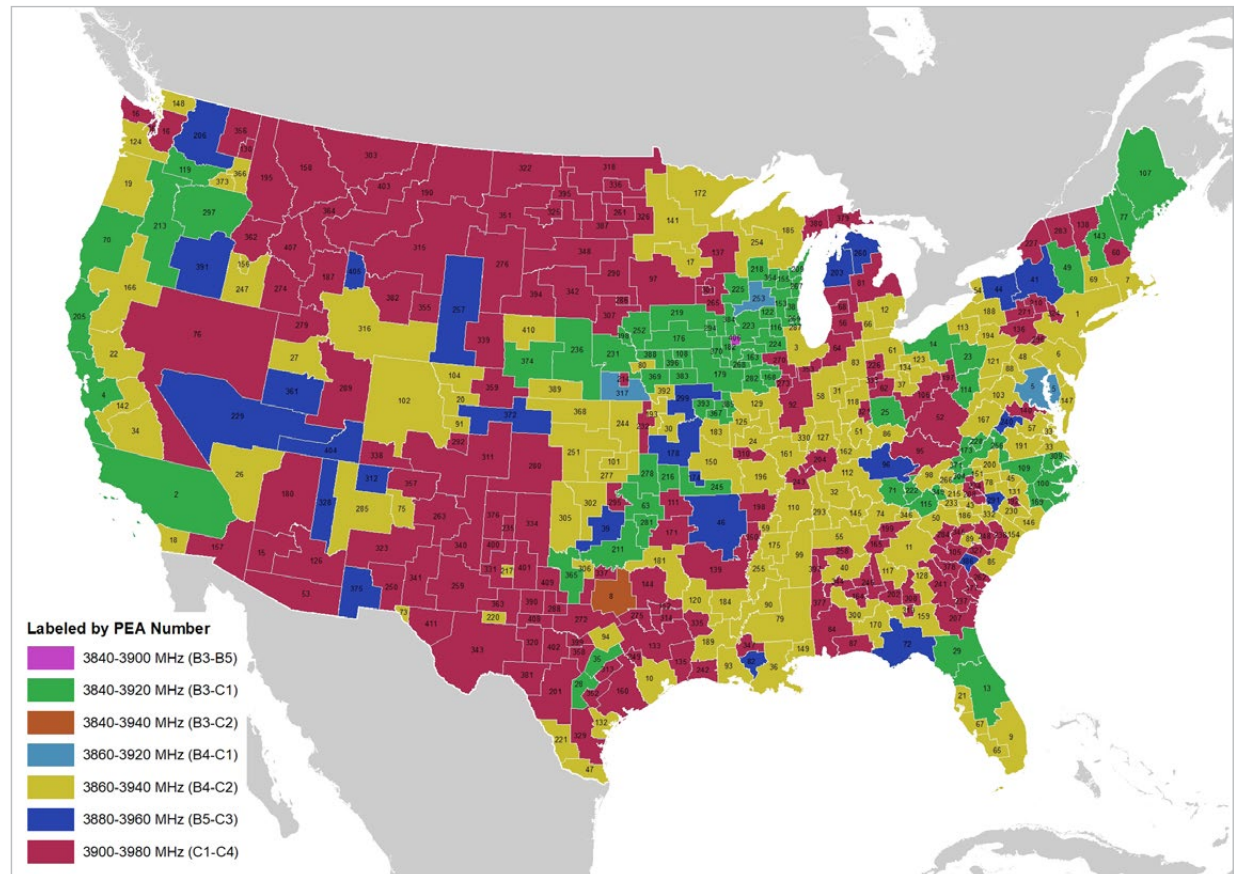

7.2: AT&T spectrum acquired in the 3.7 GHz band

Other recent LTE FDD/TDD auctions

Other auctions have been held for the Citizens Broadband Radio Service (CBRS) in 2020, the 3.45 GHz band in 2022, the 2.5 GHz band in 2022, plus many others all over the world.

Upcoming spectrum auctions

The next bands that could be made available through auction include 3.1 GHz (3100–3450 MHz), 4.4 GHz (4400–4940 MHz) and 12.7 GHz (12.7–13.25 GHz). The 3.1 GHz and 4.4 GHz band have been identified by CTIA as key for the spectrum pipeline (<https://www.ctia.org/news/three-mid-band-spectrum-bands-offer-greatest-potential-to-meet-5g-demand-in-the-us-study-finds>). The FCC has also indicated their interest in studying how to make the 12.7 GHz band available (<https://docs.fcc.gov/public/attachments/DOC-388708A1.pdf>). These bands comprise up to 1300 MHz of spectrum that could be made available in the next few years to accommodate next-generation wireless systems.

Millimeter wave bands

High-frequency millimeter wave bands provide a substantial amount of spectrum for wireless networks, albeit for short-distance communications (due to propagation limitations). Spectrum in the 24 GHz, 28 GHz, 37 GHz, 39 GHz and 47 GHz bands has been

auctioned for next-generation wireless networks.

The total amount of spectrum available in these bands is 4.95 GHz. In addition, the terahertz bands (300–3000 GHz) are also being studied for their ability to support next-generation wireless networks. It's worth noting that the FCC's table of frequency allocations stops at 275 GHz; significant work will be required to open those bands for commercial use. Propagation limitations above 95 MHz will have a direct impact on how this spectrum is ultimately used.

Buying or swapping spectrum

Just like managing a baseball team, different wireless operators have unique network needs and resources available to them. It can be mutually beneficial for operators to purchase, sell or lease licensed spectrum as a means of improving service and profitability. Such leases may be for an individual market or multiple markets. Such swaps must be approved by the governing regulatory agency.

Sharing LTE bands: FDD and TDD

To allow full duplex—that is, two-way—communication, LTE

bands employ two main methods. They are frequency division duplexing (FDD) and time division duplexing (TDD).

FDD works by using separate frequency bands for base station downlink transmission and uplink reception, while TDD refers to duplex communication where the downlink is separated from the uplink by assigning different time slots in the same frequency band. TDD requires precise synchronization of base stations to avoid passive intermodulation (PIM) interference.

Unlicensed spectrum

Unlicensed spectrum is available to users without having to secure a license from controlling regulatory agencies. Applications using these frequencies include such everyday uses as Wi-Fi, microwave ovens, baby monitors, security cameras, wireless headsets, heart monitors, cordless telephones, key fobs, smart suitcases and even smartphones. The Consumer Technology Association estimates that unlicensed spectrum generates \$95.8 billion in sales value for unlicensed devices (<https://www.cta.tech/Resources/Newsroom/Media-Releases/2022/January/Unlicensed-Spectrum-Generates-95-Billion-Per-Year>). Unlicensed spectrum can be accessed by anyone, but interference is managed through power limitations, spectrum usage etiquette and technology considerations rather than licensing specific frequencies. Because licensed spectrum is so hard to obtain, wireless network operators have turned to using unlicensed spectrum on a limited basis.

CBRS and dynamic sharing

Another spectrum option in the United States is the Citizens Broadband Radio Service (CBRS), which operates in the 3.5 GHz band (3550–3700 MHz). This spectrum had traditionally been used by the U.S. military for operation of shipborne radar, among other uses. To tap into this spectrum, an operator must employ a

Spectrum Access System (SAS) that manages spectrum assignments across commercial spectrum users. The SAS gives first priority to military and other incumbent users; second priority to priority access license (PAL) users, who acquire licenses to use CBRS spectrum through an auction; and, finally, third priority to general authorized access (GAA) users. This spectrum management scheme is called “dynamic sharing,” as it apportions spectrum assignments among users on a dynamic basis. The CBRS spectrum was auctioned in 2020 for a broad range of uses, from traditional wireless carriers to local private networks.

Dynamic sharing is also being used in the 6 GHz bands (5925–7125 MHz) through an Automated Frequency Coordination (AFC) system to allow unlicensed devices to share spectrum with incumbent microwave systems.

Both SAS and AFC enable spectrum sharing where relocation of incumbent systems is not feasible.

Managing what you have

As difficult as it is to obtain spectrum—whether bought at auction, traded from another network or approved to run on unlicensed bands—the real challenge is managing it for maximum utility. To do that, you must know the strengths and weaknesses inherent in the bands you’re using.

For instance, higher-frequency bands generally support wider channel bandwidths, which provide greater capacity.

Unlicensed spectrum

Ranges of the EM spectrum that do not require a license to use. Unlicensed spectrum can be accessed by anyone but introduces challenges of interference when competing signals occur nearby.

However, their propagation characteristics limit them to nearly-line-of-sight configurations and shorter distances depending on the frequency. Lower frequencies with narrower channel bandwidths travel farther and are less affected by obstacles, but generally don't provide the capacity modern networks (particularly 5G) require.

This introduces related challenges in how to construct or upgrade cell sites to use broad ranges of spectrum. For example, when building a new site, its location becomes increasingly important due to the propagation limitations of higher frequencies. When upgrading existing sites, adding larger, lower-band antennas to the tower introduces wind and weight load concerns.

Interference and filters

New sites are hard to secure and expensive to build. An attractive alternative is to upgrade existing sites to support more spectrum or add new infrastructure to a co-sited arrangement with another network. In both cases, interference can be a significant challenge. We cover common interference challenges in Chapter 5 (isolation) and Chapter 6 (passive intermodulation, or PIM).

- Interference caused by external sources, however, can come from just about anywhere: other cell networks, radar, motors, spark plugs, nearby high-voltage lines and other sources. Interference robs capacity from any given signal, so successful spectrum management

depends on a low-interference RF path. Interference mitigation filters (IMFs) are small devices inserted into the RF path that allow only specific frequencies to pass through. IMFs can help mitigate interference in both the uplink and downlink—maximizing the potential throughput.

- PIM is generally caused by discontinuities in the RF path. These may be caused by moisture in a transmission line, an improperly torqued or corroded connector, or a crushed coaxial cable. Interactions of different frequencies operating nearby can also cause such discontinuities.

Multiplying challenges

PIM can also be caused by combining two or more frequencies that multiply and create new interfering signals. These mathematical combinations of two or more frequencies—PIM products—can cause interference not only in their own band, but also in multiples of that band. They are often referred to as second-order PIM, third-order PIM and so forth. Higher orders create less interference but cover a wider swath of spectrum. You can learn more about PIM in Chapter 6.

Planning a successful site upgrade

To avoid or overcome these challenges, it's important to consider many factors when planning a site.

Antenna considerations:

- **Spectrum support.** Most antennas support more than one band. Adding new spectrum to an existing site requires a replacement antenna that supports both current and new frequencies, so the network must ensure it can provide enough capacity on both the transmit and receive paths. It is also essential to perform a PIM analysis that includes the existing new bands.
- **TDD or FDD?** As explained above, to maintain a duplex connection, the network must split the signal, either by separating them into two frequencies or two time division schemes. (It is worth noting that TDD is not truly duplex; it emulates duplex signals by dividing the transmit and receive paths into two different timing schemes.) Regulatory licenses typically specify which method should be used.
- **Beamforming.** As networks deploy more sites and more antennas, there is a corresponding need to mitigate interference between sectors. Beamforming helps concentrate coverage and reduce overlap with adjacent cells.
- **Vertical vs. horizontal separation.** As we covered in Chapter 5, horizontal and vertical separation can help isolate antenna signals and avoid interference.

Other site logistics:

- **Sufficient power and backhaul.** Adding radios to support additional spectrum means the site will draw more power, so adequate available DC power must be ensured. Also, since more traffic will be using the RF path, it's critical to ensure adequate backhaul capacity—either by fiber-optic cable or microwave. We cover site power in Chapter 10 and backhaul in Chapter 8.
- **NOTE: More than creating cost and complexity issues, adding more radios increases the network's carbon footprint.** One way to partially offset this is to ensure the new radio/antenna system is right-sized for the estimated capacity and coverage demands of the site. (Reference to Omdia white paper on 8T8R: <https://telecoms.com/intelligence/supporting-service-providers-on-their-journey-to-net-zero/>)
- **Weight and wind load.** Additional antennas, filters and radios needed to support new spectrum can add a great deal of weight to a cell tower, as well as introduce greater wind loads. These must be checked against specifications before deployment of additional tower-top infrastructure.
- To reduce tower stresses, using diplexers and triplexers can reduce the number of cables needed to connect tower-mounted radios and the baseband equipment on the ground by allowing each one to carry more than one signal at a time. This also further minimizes the network's environmental impact.
- At higher frequencies, tower-mounted amplifiers (TMAs) can overcome the uplink coaxial cable losses; however, being mounted atop the tower, they mean more weight and wind load to contend with.
- New structural steel solutions provide more robust, rigid and durable mounting structures for additional components (see Figure 7.3).

For all wireless operators, small cells are a vital component to using spectrum in the higher frequency bands—exploiting the bands’ strengths and mitigating their weaknesses. The use of higher-frequency bands will only increase as time goes on and next-generation networks become a market reality.

Get the most from your spectrum

Available spectrum is scarce and getting scarcer, even as demand continues to rise. This means wireless operators must squeeze every last bit from their networks.

Managing spectrum starts with understanding it—how different bands offer unique advantages. There is more than one way to acquire spectrum, but none of them are easy or inexpensive, and deploying new or additional spectrum comes with an environmental cost. Whether won at auction for millions or billions of dollars, leased, or used in unlicensed bands, operators must ensure that every bit of spectrum they use is working its hardest and delivering the most revenue possible.

CommScope has long been at the forefront of the industry as a trusted partner with the technology and expertise to put valuable and limited spectrum resources to their best use.

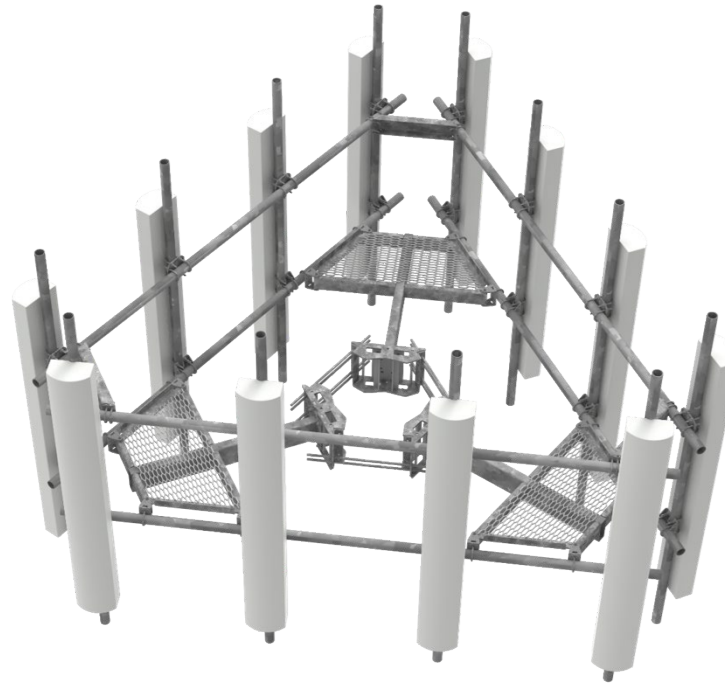

7.3: CommScope’s high-capacity Atlas Monopole Platform, designed and tested for 180 mph wind loads and rated up to M2200R(1700)4-[6] per TIA-5053

Chapter 7 summary

Gaining spectrum

- Regulatory auctions
 - High prices, low availability
 - Several recent auctions and upcoming auctions putting more spectrum in the pipeline
- Spectrum can be bought from or swapped with other networks
- Unlicensed spectrum
 - Free to use but of limited utility due to lower powers
 - Not yet a reliable cellular alternative
- Infrastructure-level spectrum management
 - CBRS requires SAS to utilize
 - IMFs reduce interference
 - PIM is an internal and external challenge
 - Power, backhaul, weight and wind load considerations all affect how one adds spectrum



Chapter 8

The infrastructure behind the call: Backhaul

Imagine two kids, each standing in their own backyards, talking to each other on soup cans connected by a string. This is the simplest of connections: nothing more than two users on a direct, point-to-point, dedicated line. This same simplicity applies if we replace the cans with walkie-talkies—the communications system is still reliant on just two points of contact.

Once the system becomes more complex—like modern distributed communications networks with millions of users—these simple connections are no longer practical or possible. A centralized processing point is needed to route many conversations simultaneously just to make the correct phone ring when you dial its number.

This is the role of the core network behind hundreds of thousands of distributed cell sites. Of course, being orders of magnitude more complex, it requires a correspondingly robust infrastructure to move that much information up and down in a fraction of a second—allowing for smooth and natural communications even when the two ends are thousands of miles apart. “Backhaul” is the collective term for this part of the RF path.

Backhaul

The process of connecting two ends of a transmission through a central routing point.

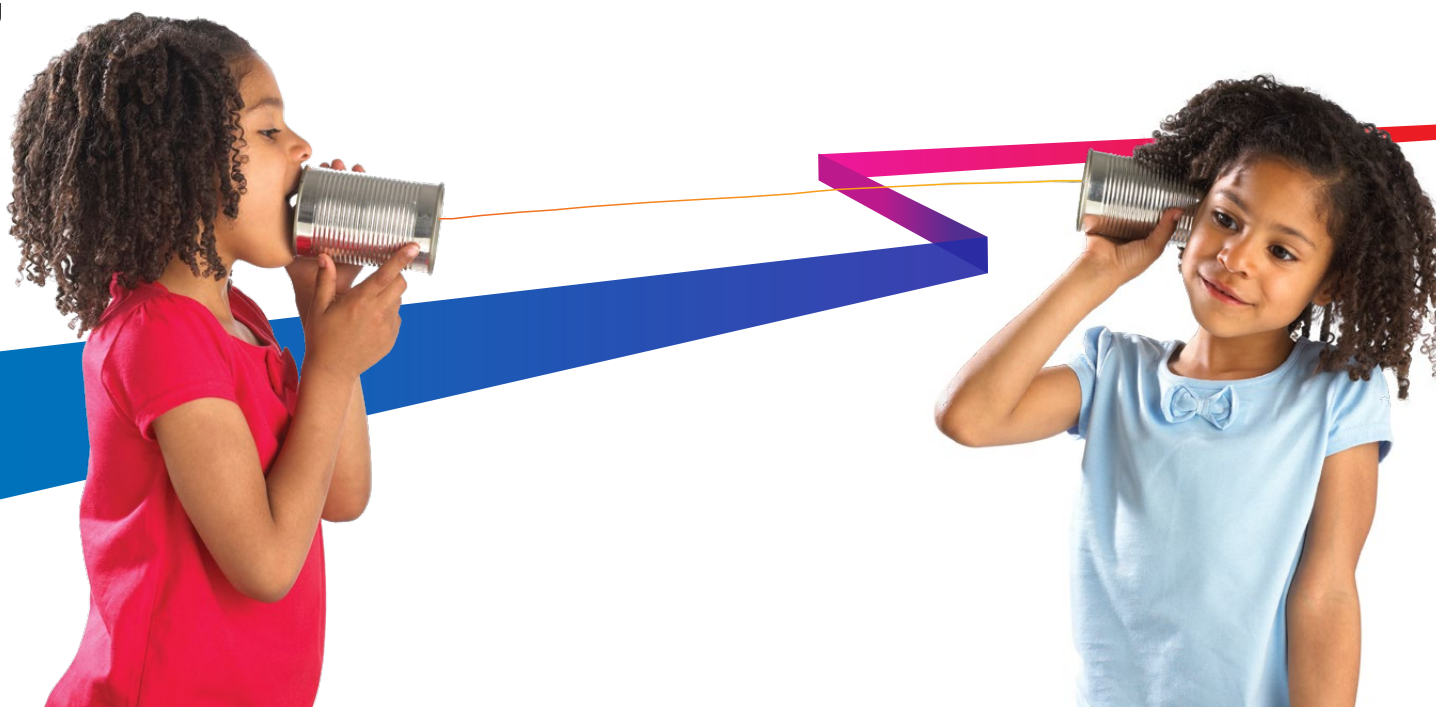

The process of routing network traffic for a cell phone call requires many steps to complete, and looks something like this:

1. Mary makes a call to Bill on her cell phone from her office
2. Mary's outbound call is picked up by the nearest cell tower
3. The tower routes Mary's call to the area's regional network
4. The regional network sends Mary's call to the national network
5. The national network routes Mary's call to Bill's regional network

6. The regional network broadcasts Mary's call from the nearest cell tower

7. Bill's cell phone rings, he answers, and the call connects

Backhaul is the process of routing Mary's cell call—along with thousands of other simultaneous connections—up and down from the core network. This includes steps 3, 4 and 5 in the example. Obviously, this kind of data aggregation requires high speed and high bandwidth in order to route connections, and there is more than one way to provide backhaul. The two most commonly used forms of backhaul in modern cellular networks are fiber-optic backhaul and microwave backhaul. Each offers specific advantages for different kinds of installations, locations and requirements.

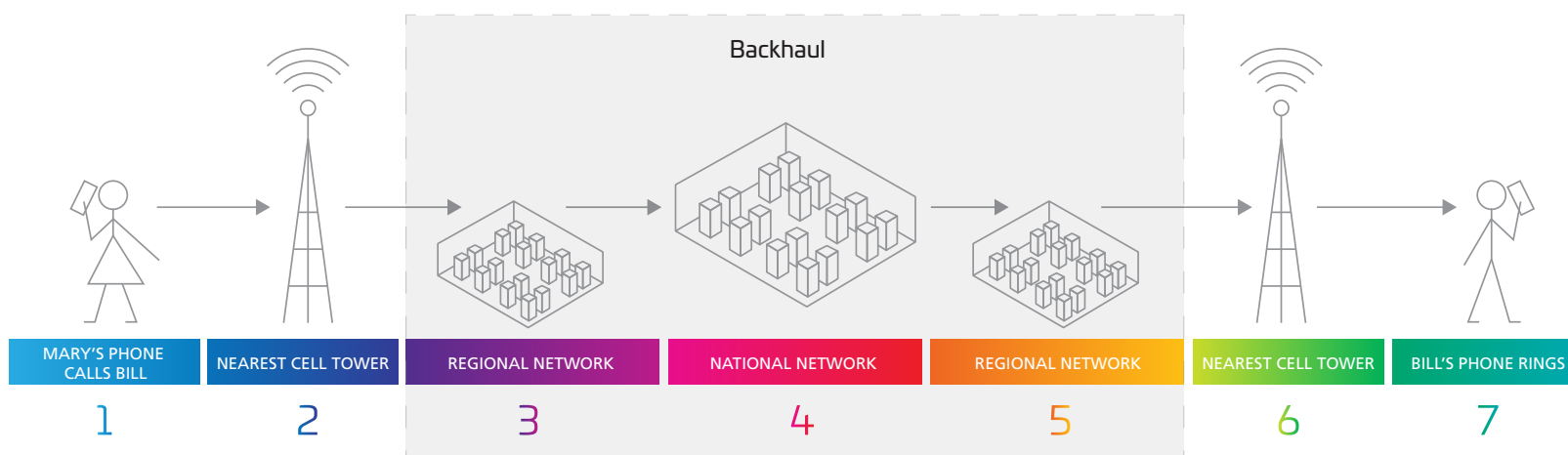

Fiber-optic backhaul

Fiber-optic backhaul uses high-speed, high-bandwidth, fiber-optic cable to move network traffic up and down the core network to individual cell sites where mobile users connect. Fiber-optic backhaul infrastructure allows the nearly-instantaneous movement of massive amounts of voice and data traffic over long distances. Like all fiber-optic infrastructure, it uses light pulses rather than electrical signals to move information. For this reason, it offers significant space to grow as new applications and cellular technologies emerge. Its capacity can be magnified by a practice called “multiplexing,” in which different wavelengths of light—different colors, essentially—move multiple data streams down the same fiber without interfering with each other.

Multiplexing is particularly useful when trying to get more capacity from an existing fiber-optic installation without laying additional cable. All it takes is the right solutions, such as CommScope’s passive wavelength division multiplexing (WDM) module, to retrofit an existing cable.

On one end of the link, WDM combines multiple wavelengths of light onto a single strand of fiber, creating independent pathways that increase the data-carrying capacity of the fiber strand. The same WDM components can also separate the combined wavelengths (de-multiplexing) on the other end. WDM modules are designed to easily integrate into existing telecom equipment. The result is a simple and efficient solution that addresses capacity shortages without spending more on power.

As sustainability and environmental impact play a greater role in network design, the ability to support growing capacity needs without increasing the carbon footprint has become a bigger benefit of multiplexing.

Wavelength division multiplexing (WDM)

The practice of sending multiple wavelengths of light down a single fiber-optic cable, making each fiber carry two or more parallel communications that are separated out at the other end.

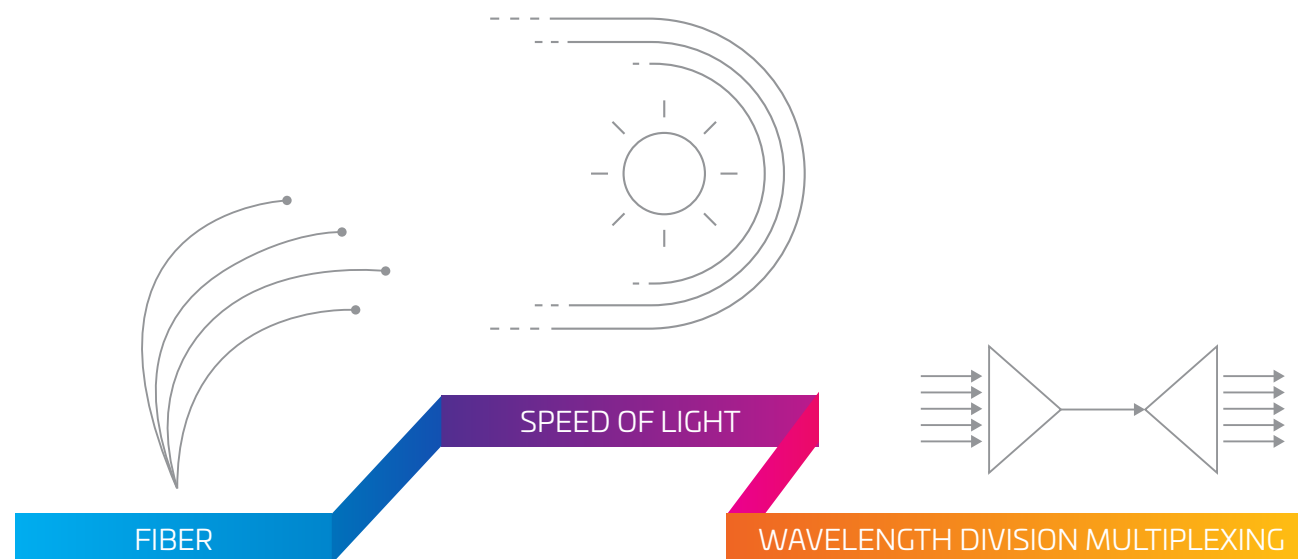

C-RAN: the evolutionary future of cellular networks

The incredible capacity of fiber-optic backhaul is driving another important trend in cellular architecture:

C-RAN. C-RAN actually denotes two distinct but related concepts: centralized radio access networks and cloud radio access networks. The former lays the foundation for adoption of the latter.

The evolution toward C-RAN began with the decoupling of the amplifiers and radios from the baseband units. The amplifiers and radios moved to the top of the tower while the baseband units remained at the bottom, connected to the core network. The next phase will see the movement of the baseband unit as well—not up the tower, but away from it. Thanks to fiber-optic efficiency and speed, the baseband unit can be located miles away, sharing space and processing power with other units from other sites. The pooled resources of the network can all be neatly located in a shared central office space that's not only easier to maintain, but also more efficient, both operationally and environmentally. In this scenario, fiber-optic backhaul technologies can also be used to enable fronthaul in the RF path as well. This is the centralized version of C-RAN.

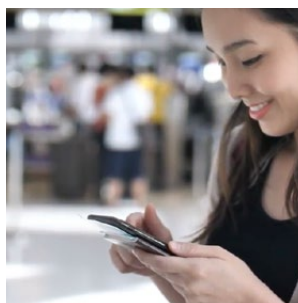
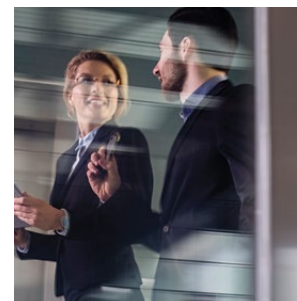

C-RAN

Two related cellular network architecture evolutions that are currently in development:

Centralized radio access networks

use fiber-optic cable to relocate the baseband units to centralized, remote locations far from their towers and radios, using backhaul-style infrastructure to support fronthaul traffic between the radio and the baseband unit.

Cloud radio access networks

replace the baseband units with virtualized baseband functions in a centralized location for even more efficiency and scalability.

Cloud RAN as a green game-changer?

Beyond the cost advantages of pooling and virtualizing dozens of physical baseband units, cloud RAN offers significant environmental benefits. Base stations today consume more than 70 percent of the total energy used in mobile networks. Much of that power is used to fuel the cooling equipment within each base station. Pooling the baseband resources in a centralized location would greatly increase the network's cooling efficiency. And that's just for starters.

Moving the baseband units and their support systems into centralized locations would enable networks to significantly reduce (or, in some cases, eliminate) the need for the traditional base station. This means reducing or eliminating the power requirements, non-recyclable waste, CO₂ and greenhouse gas (GHG) emissions required to build, operate and service millions of base stations.



Once the centralized RAN becomes reality, and the fiber-optic fronthaul to remote sites is in place, the next step is to eliminate the physical baseband units altogether. This is the vision of cloud RAN. Cloud RAN would replace the

physical BBUs with virtualized BBUs, pooled and operating in data center-style cloud environments (Figure 8.1).

This technology offers cellular operators unprecedented flexibility, scalability and efficiency.

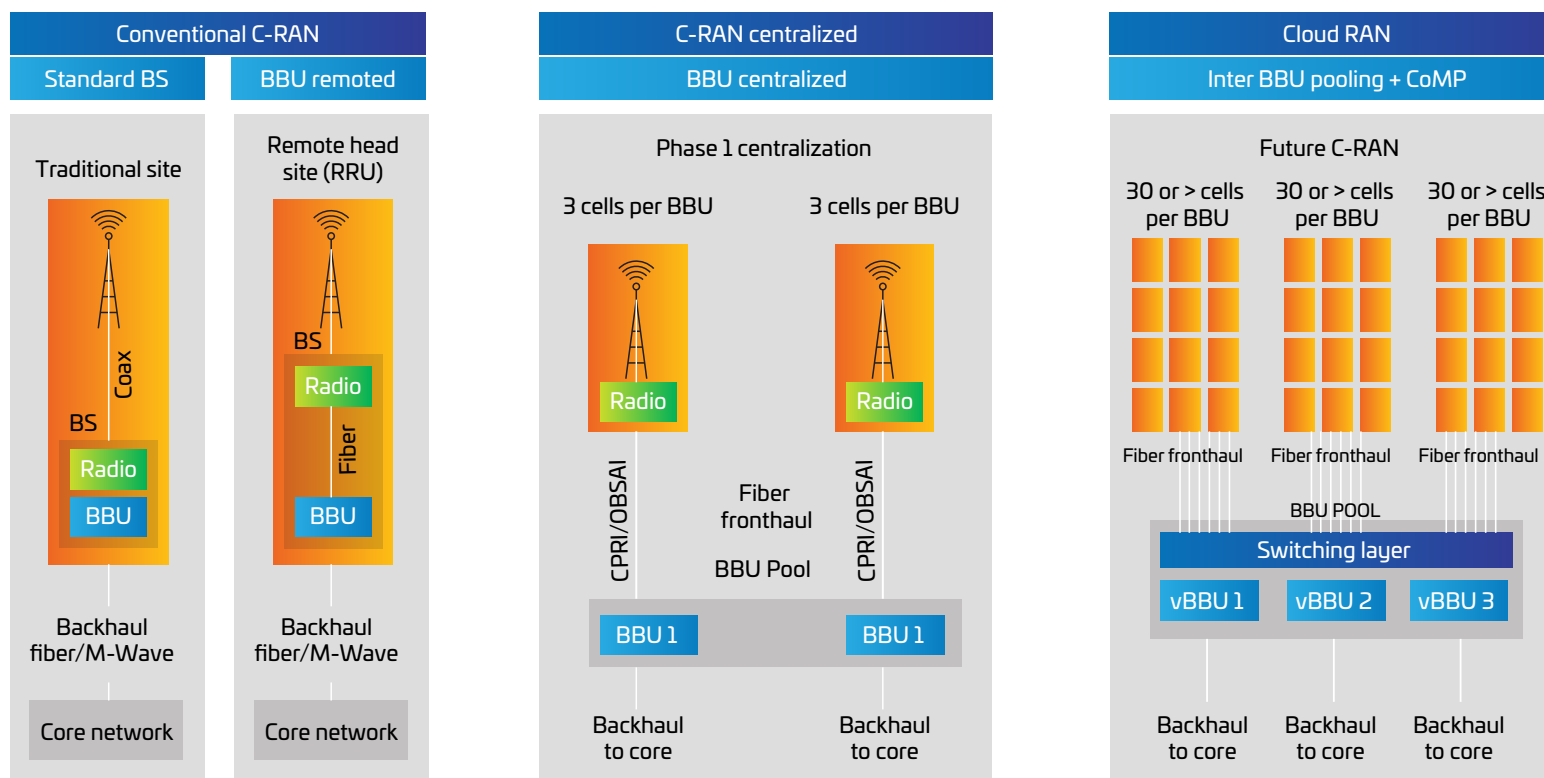

8.1: The evolution from RAN to centralized RAN to cloud RAN

Fiber isn't always the right solution

Despite its speed and flexibility, fiber-optic backhaul isn't a universal solution. Factors like economics and logistics can make fiber-optic backhaul impractical or even impossible for particular cell sites. For example, running fiber backhaul underground can be costly and time-consuming depending on the location and local regulations. The flip side, however, is that, in some locations, the ability of fiber-optic backhaul to maximize a site's revenue potential can justify these additional investments.

The bottom line is that fiber backhaul does have many strategic advantages, particularly its vast capacity. In locations where it can be installed or connected to an existing fiber-optic network, it is considered the go-to solution. But that is not always the case. In the next section, we will see how a complementary technology, microwave backhaul, also fills an important role.

Microwave backhaul

Microwave backhaul accomplishes the same function as fiber-optic backhaul, but without the fiber-optic cables. Instead, it utilizes a network of powerful and precise point-to-point microwave antennas to link cellular traffic between sites and the core network.

Microwaves comprise a discrete range of the electromagnetic spectrum in the super high and extremely high frequency bands. Like other bands, microwaves are expressed in hertz (Hz), a measurement of a particular radiation's frequency. Most frequencies used in electronics are expressed in thousands of hertz, or kilohertz (KHz); millions of hertz, or megahertz (MHz); billions of hertz, gigahertz (GHz); or even trillions of hertz, terahertz (THz). Some of the more familiar types are listed in Table 8.2. As you can see, microwaves are among the higher frequencies used in communications.



Line of sight (LOS)

The unobstructed space between transmitter and receiver. Longer hops must even account for the obstructive effects of the Earth's curvature

Microwave backhaul is an attractive alternative to fiber-optic backhaul when site locations are particularly remote or inaccessible—or where permits cannot be secured to lay fiber-optic infrastructure. It moves aggregated traffic from one antenna to the next, where it can be routed to a third, then a fourth or as many “hops” as it takes to reach the designated core network access.

Globally, around 65 percent of all mobile data traffic is transported using microwave backhaul at some point on its journey. In some cases, it may be a simple hop from the cell site to the nearest fiber access point.

These hops are also called “links,” and they can be many miles long. As a line-of-sight (LOS) solution, microwave backhaul antennas can direct a concentrated beam of information to a similar receiving antenna as long as there exists direct, unbroken clearance between the two antennas. For this reason, microwave antennas are mounted high enough on the tower to “see” their distant reception points.

Frequency band	Frequency (GHz)	Typical maximum hop length (km)	Typical minimum hop length (km)
0.9 (unlicensed)	0.902–0.928	100	–
2.4 (unlicensed)	2.4–2.5	100	–
4	3.6–4.2	70	24
5	4.4–5.0	60	16
5 (unlicensed)	5.3, 5.4 and 5.8	50	–
L6	5.925–6.425	50	16
U6	6.425–7.125	50	16
L7	7.1–7.75	50	10
U8	7.75–8.5	50	10
10	10–10.7	20	10
11	10.7–11.7	20	10
13	12.7–13.25	20	6
15	14.4–15.35	20	6
18	17.7–19.7	20	2
23	21.2–23.6	20	2
26	24.25–26.5	20	2
28	27.5–29.5	15	2
32	31.0–33.4	10	1.5
38	37.0–40.0	10	1
42	40.5–43.5	10	1
60 (unlicensed)	57.0–66.0	1	–
80	71–76/81–86/92–95	5	–

8.2: Typical hop lengths for microwave frequency bands

Microwave advantages

The microwave band possesses characteristics that make it a flexible solution, lending itself to multiple environments:

- The low end of the band (below 11 GHz) propagates over long distances, making it ideal for long-haul connections to users in remote locations.
- The higher end of the band (above 11 GHz) propagates over shorter distances, making it ideal for short-haul connectivity required in urban locations.

In addition to their technical characteristics, microwave links offer practical and financial advantages over cable solutions. These advantages have made them a popular alternative for modern communications networks:

- They are less expensive to install than fiber-optic solutions, and less expensive to operate than copper-based backhaul infrastructure.
- They can be quickly deployed with less zoning and regulatory overhead than digging to install any kind of backhaul cable.
- Modern microwave backhaul solutions offer bandwidth that approaches that of fiber-optic backhaul—and far exceeds anything possible with earlier-generation copper infrastructure.
- They are scalable and highly reliable when quality antennas are properly installed.



Microwave backhaul in action

Let's revisit Mary's cell call to Bill described at the beginning of this chapter. Mary calls Bill and the cell phone connects with the nearest cell tower, operating on the network's radio frequencies (within the 700–2700 MHz part of the spectrum). The cell tower hands off the call to a microwave transmitter (typically operating in the 6–40 GHz bandwidth). The microwave transmitter beams the call wirelessly to a collection or aggregation center, which connects to the mobile network's core network. The traffic is then routed across the network to the region closest to the receiver's location, to be transmitted again by microwave to the nearest cell tower.

The receiving cell tower station down-converts the microwave signal back to the network's radio frequencies for its final journey to the target cell phone.

Duplex communications

A transmitter and receiver that work in different time slots or frequency slots on the same device.

The process is reversed for traffic moving in the opposite direction. This two-way, or duplex, microwave backhaul generally uses a frequency-division duplex (FDD) system that allocates frequency channel pairs for simultaneous two-way, or duplex, communication (Figure 8.3).

Another way to achieve duplex communication is via a time-division duplex (TDD), which achieves the same goal by switching the required direction of transmission in a very fast, precise manner (Figure 8.4). While a more efficient option, TDD requires very careful timing control and is not the preferred system for microwave use.

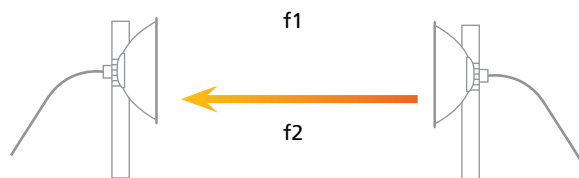

8.3: Frequency-division duplex (FDD) system with separate go/return frequencies

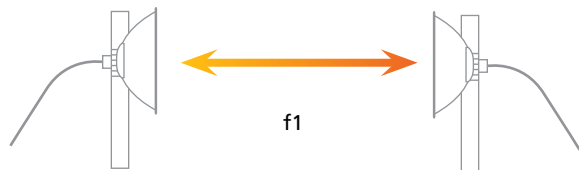

8.4: Time-division duplex (TDD) system using just one go/return frequency

Network capacity and demand management

Simply put, capacity is a network's ability to handle transmission traffic. In the case of cell communications, this traffic means voice and data—often a great deal of data. As capacity demands continue to rise with the wide adoption of 4G/LTE/5G devices all over the world, smart spectrum planning becomes even more important to assure headroom for tomorrow's data-hungry applications. There are a number of critical tools at the network planner's disposal.

Modulation. One way to boost microwave capacity is by adjusting the “modulation.” By employing different modulation schemes, more traffic can be squeezed into the limited bandwidth. The tradeoff is that higher modulation schemes require higher signal-to-noise performance to maintain the integrity of the data. This increases power requirements and the associated operating and environmental costs. Modulation is also subject to environmental effects, which we will explore later in this chapter.

Adaptive modulation. Adaptive modulation scales the amount of signal modulation as link conditions change. For example, if rain or other factors are present, modulation is dialed down to maintain error-free (if somewhat slower) traffic rates. When the link condition improves, modulation is automatically increased to take advantage of prevailing conditions. Adaptive modulation has been universally adopted as operators seek to balance increasing traffic and reliability needs.

Co-channel dual-polar operation. Another capacity-boosting technique, called “co-channel dual-polar” (CCDP) operation, leverages the polarization characteristics of microwaves. It enables two streams of traffic to travel the same bandwidth at the same time—one vertically, one horizontally. CCDP is often used in short-haul antenna systems where an integrated dual-polarized antenna featuring an ortho-mode transducer (OMT) connects two outdoor unit radios to a single antenna. This arrangement maintains a high level of isolation between the two signals for maximum clarity (Figure 8.5).

Millimeter wave spectrum. To gain even more capacity, operators are using higher and higher frequencies. At the millimeter wave (mmWave) bands, above 70 GHz, bandwidths are ultra-wide—enabling fiber-like capacities of 10 Gbps and higher. However, at these higher frequencies, the range is limited (see Figure 8.2). After about 3–5 km, link availability falls below acceptable levels.

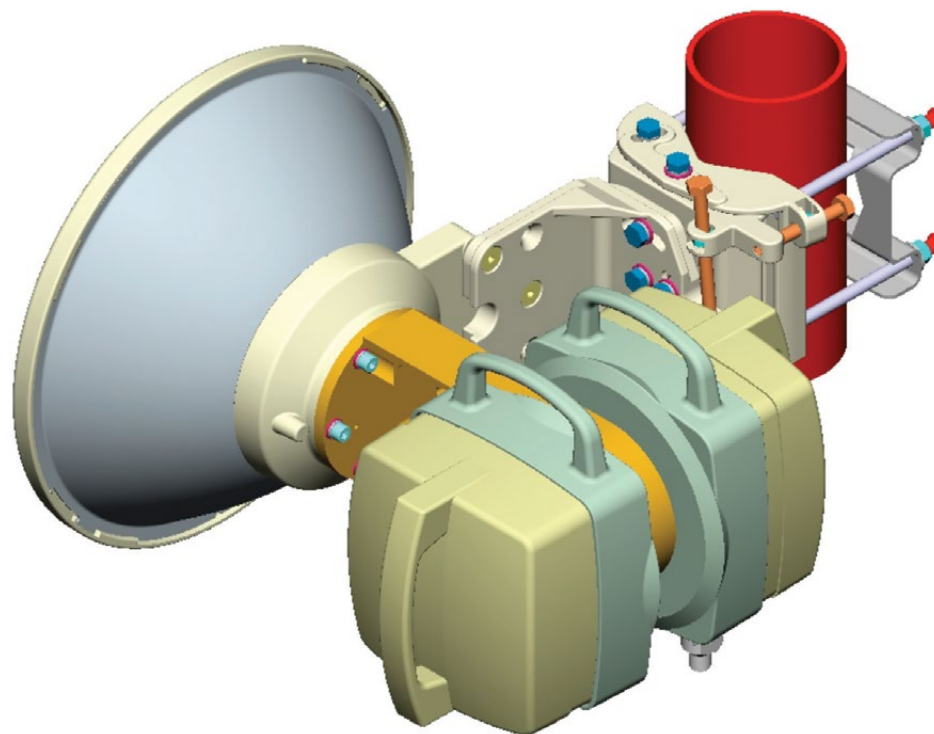

8.5: An example of an integrated dual-polarized antenna

Microwave link aggregation to the rescue

So, what if you want the high capacity of mmWave and the longer link lengths of the lower microwave frequency bands? This is one of the major benefits of microwave link aggregation. It essentially creates two links. One uses a traditional lower microwave frequency like 23 GHz, and another uses an mmWave band such as E-band (70 GHz). By aggregating the capacity of these two links, operators can achieve the maximum throughput of the E-band link in good weather conditions, while maintaining the reliable connection of the 23 GHz link (at a lower capacity) when poor weather takes the E-band link offline.

The downside of this solution is that it requires an antenna for each link and the available tower space to mount them. Definitely not ideal. Therefore, to make link aggregation faster, easier and more cost-effective to deploy, CommScope developed a dual-band antenna designed for link aggregation. It effectively combines two frequency bands into a single antenna. Additionally, CommScope's comprehensive iQ.link microwave link design software includes all the features necessary to design and manage link aggregation, presenting the availability and capacity of the links—both independently and as a combined solution.

8.6: Source: RCR Wireless, August 28, 2019

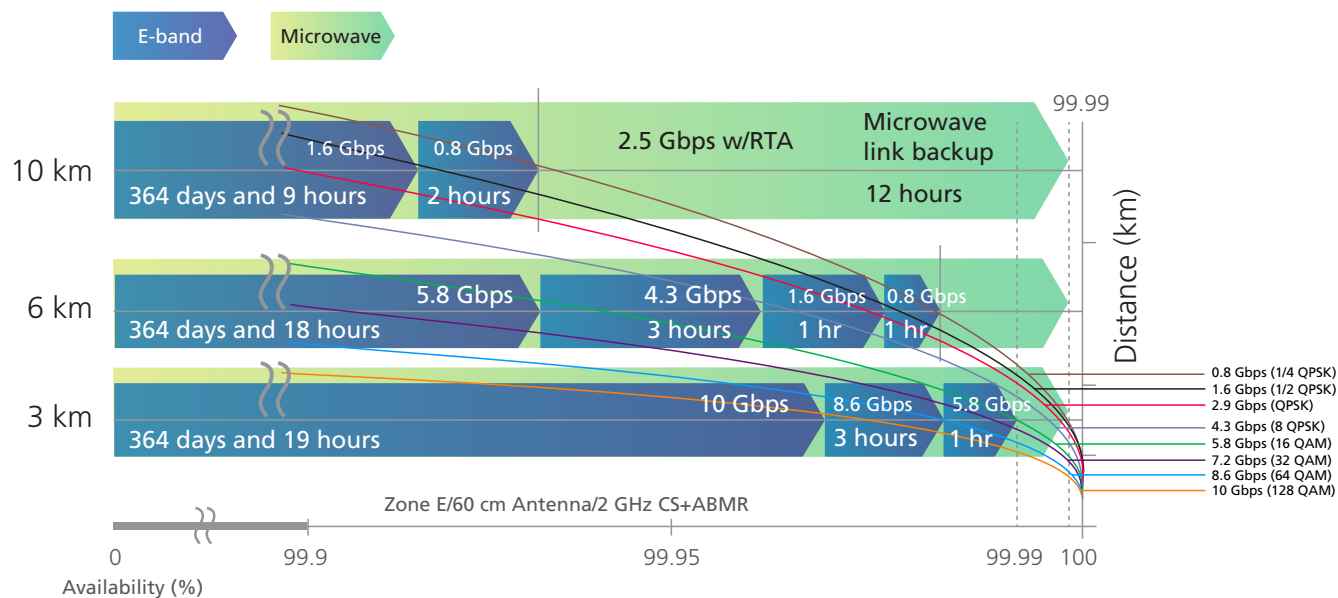

Typical microwave deployments

For best LOS clearance, microwave antennas are often mounted on towers or at the top of high buildings. To maximize the value of these choice locations—and to reduce the costs for leasing these locations—microwave backhaul antennas are often mounted adjacent to base station antennas, which also rely on altitude for efficient operation (Figure 8.7).

Many short-haul installations, typically those operating above 11 GHz, use a split-mount radio system, which divides the radio into an ODU and an indoor unit (IDU). The ODU houses the microwave circuitry, including the go/return signal-separating diplexer and the up/down frequency converters. It is mounted in an enclosure adjacent to the antenna—or more frequently integrated into the antenna assembly itself (Figure 8.8).

The IDU contains the modulator/demodulator (a.k.a. modem) and the control circuitry that translates the cell phone traffic into a form suitable for microwave transmission.

Split-mount radio system

A two-stage connection that lets microwave radios located in an indoor unit (IDU) receive and transmit through an antenna fitted with an outdoor unit (ODU).

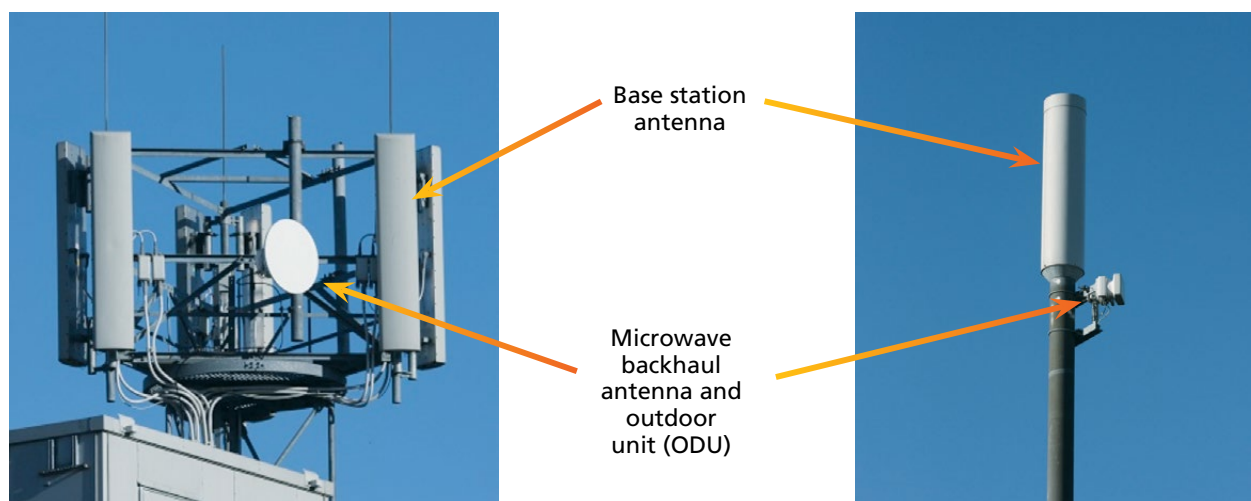

8.7: Typical microwave backhaul antenna integrated into a base station antenna location

For high-density traffic and long-haul hops, multiple radios are typically housed in a remote radio room adjacent to the base of the tower. Generally, these hops use larger antennas operating at frequencies under 11 GHz (Figure 8.9).

Connections between the antenna and the radios are made by coaxial cable or elliptical waveguide, depending on the frequencies involved (Figure 8.10). For tower-mounted outdoor radios, fiber-optic jumper cables carry the data stream straight to the radio on the back of the antenna.

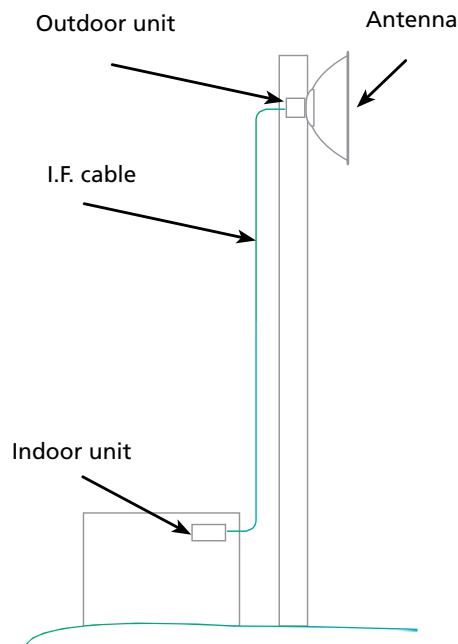

8.8: Typical split-mount microwave radio system showing IDU and ODU



8.9: A typical lower frequency aggregation point

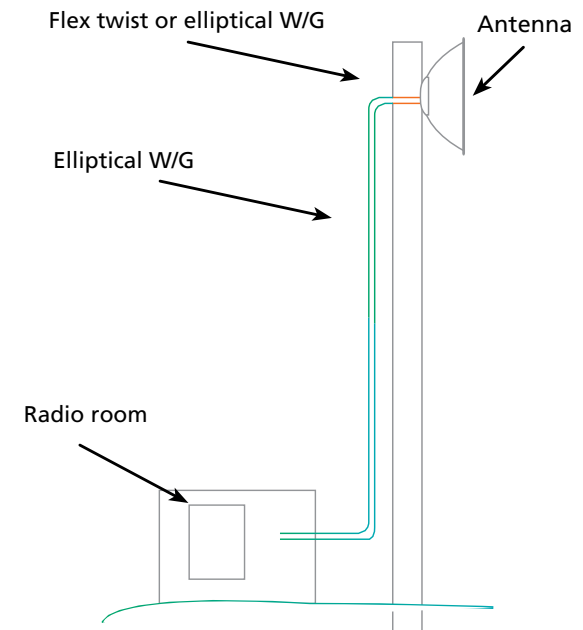

8.10: Connections between remote microwave radios and a microwave antenna

Planning a microwave link

When considering a new microwave backhaul path, interference is a major concern. The planned link must not interfere with adjacent links or other operators in the area. To prevent conflicts and other problems, you must consider:

- Frequency coordination with other links in the vicinity
- Radio and radiation characteristics of the antenna
- Transmission power levels

To avoid these issues, industry standard software tools, such as iQ.link from CommScope, can smooth the planning process and assist in providing a regional overview of active area networks. Antenna manufacturers offer assistance as well, providing planners with the radiation pattern envelope (RPE). An RPE document includes a performance summary and the key specifications related to antenna gain, beamwidth, cross-polar performance and radiation patterns (Figure 8.11).

The chart describes the directional properties of the antenna by mapping its directionality (in decibels) against its azimuth angle. As this chart shows, the envelope has a main beam area at zero degrees, corresponding to the electrical axis of the antenna. This is the line-of-sight direction where the directionality is at its maximum.

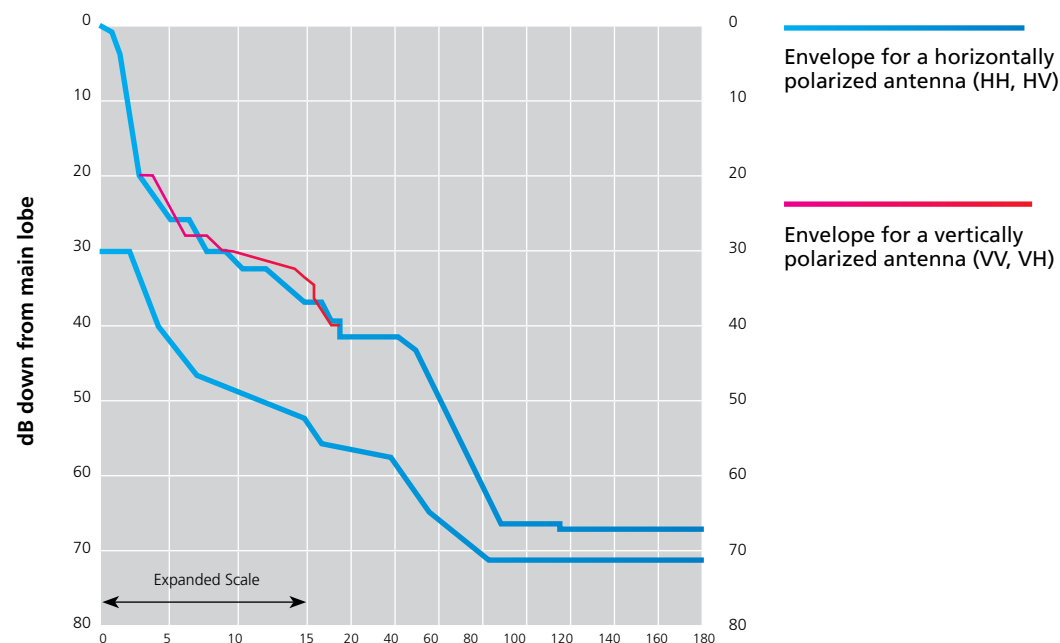

8.11: A typical radiation pattern envelope (RPE) document

Away from the main beam, the directionality quickly decreases. This corresponds to a drop-off in antenna sensitivity, whereby signals transmitted or received away from the on-axis direction reduce rapidly. The link planner uses this information to determine how much of their new proposed link signal will deviate from the intended direction and assess whether this is likely to present interference problems.

Because of their importance in the planning process, RPE documents are strictly regulated. In Europe, the European Telecommunications Standards Institute (ETSI) publishes several classes of envelope standards that all antennas must satisfy. A Class 2 antenna may be permissible in locations where interference is not an issue, but it cannot be used where a stricter Class 3 standard is required.

There is a growing trend to the more stringent Class 4 specification, which represents a significant advance over earlier standards.

Sidelobes, reuse, and the Class 4 advantage

Class 4 antennas feature lower sidelobes than Class 3 alternatives. This means more of their signal energy is directed at its target, and less “leaks” around the edges of the beam or behind the antenna. Sidelobe (along with sidelobe suppression) are important metrics of efficiency that allow a Class 4 antenna to support much higher link densities than a Class 3 antenna (Figure 8.12).

Because their low sidelobes create so little interference, Class 4 antennas—for example, CommScope’s Sentinel® solution—can provide 40 percent greater spectrum reuse, essentially creating capacity simply by using available spectrum more efficiently. Adding adaptive modulation

enables the radio to maintain the highest modulation states for longer in adverse conditions, maximizing capacity over the link.

Depending on the characteristics of the link and the unique low sidelobes, it may be possible to deploy a smaller diameter Class 4 antenna than would be needed if a Class 3 antenna were used—reducing tower loading and saving lease costs.

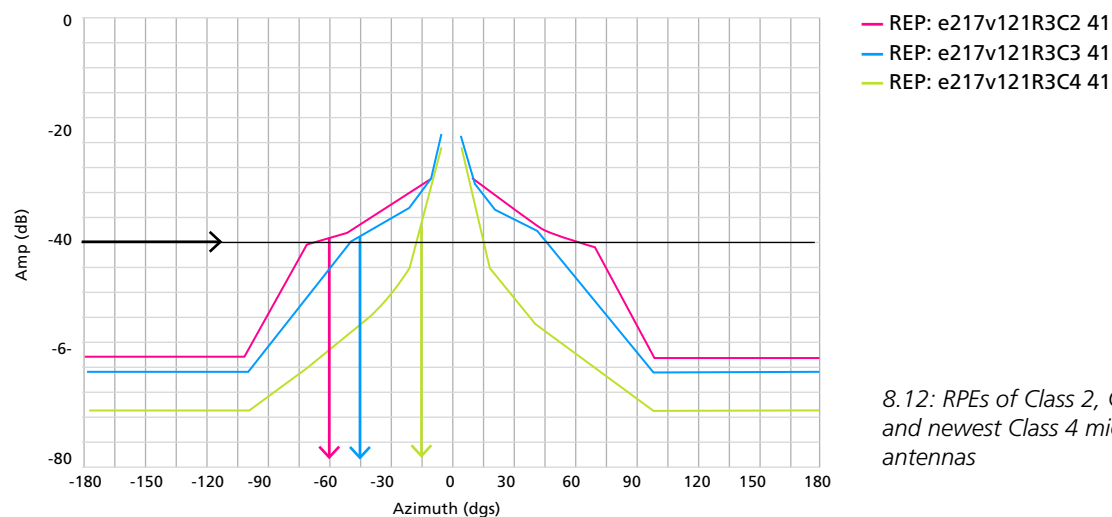

8.12: RPEs of Class 2, Class 3 and newest Class 4 microwave antennas

Protecting microwave systems from the elements

Like every step along the RF path, backhaul must be always reliable and available. Downtime means lost revenues, irritated customers and expensive repairs. In practical terms downtime is measured as a percentage of time or in minutes per year (Table 8.13). A detailed explanation of reliability predictions and measurement can be found in Chapter 11.

Downtime, minutes per year	Availability
525.6	99.9000%
52.56	99.9900%
26.28	99.9950%
5.256	99.9990%

8.13: Downtime in minutes per year and corresponding availability percentages

As an outdoor wireless network is continuously exposed to the elements, certain reliability-limiting factors are unavoidable:

- Precipitation and moisture
- High winds
- Temperature variances
- Lightning strikes
- Atmospheric refraction

Fortunately, each challenge to reliability has an available mitigating measure.

Rain and snow

As mentioned earlier, lower-frequency microwave bands propagate very well across long distances, allowing hops of 50 kilometers or more. So, distance is not the most significant limiting condition; atmospheric conditions are, with rain being a chief culprit. Rain falling through the signal path reduces signal strength—an attenuating phenomenon known as “fade.”

In frequencies above 11 GHz, rain-induced attenuation becomes more pronounced, reducing hop distances accordingly. Rain—and, to a lesser extent, snow—can scatter signals in these frequencies. The degree of impact depends on the rate of precipitation, the frequency involved and the signal’s vertical or horizontal polarization.

Horizontal signals are more adversely affected by rainfall due to the shape of raindrops as they fall. This makes vertical polarization the preferred orientation. Fortunately, it is possible to mitigate rain’s effects by using the calculations of rain outage models and building enough safety margin into the transmission power levels to compensate for expected loss. This will ensure a reliable hop between stations. Modern microwave radios will even adjust power on the fly when needed, using an automatic transmission power control (ATPC) system.

Signal polarization

The orientation of a signal’s electric field relative to the ground. It may be horizontal or vertical.

Automatic transmission power control (ATPC)

A system that dynamically raises transmission power to overcome the effects of interference.

Precipitation also interferes with polarized transmissions through an effect called “polarization rotation.” This phenomenon essentially rotates the signal polarity enough to interfere with other signals. To counter this effect, a cross-polar interference canceller (XPIC) samples signals in both polarities, producing a wave that cancels out the interfering, “rotated” part of the signal.

Adaptive modulation

Another technique with widespread acceptance in microwave backhaul applications is called “adaptive modulation.” In addition to compressing, or modulating, network traffic into smaller bandwidths at higher signal

levels, adaptive modulation adjusts the amount of modulation in response to any link impediments. The result is that adaptive modulation can dynamically reduce traffic to compensate for the impaired signal level while still maintaining the link, albeit with lower capacity.

Rain mitigation methods can also be built into the link designs. In multiple-hop situations, for example, mesh and ring topologies provide alternative signal paths that bypass problematic hops by rerouting around them. Path selection is dynamic and adapts on the fly to changing conditions (Figure 8.14).

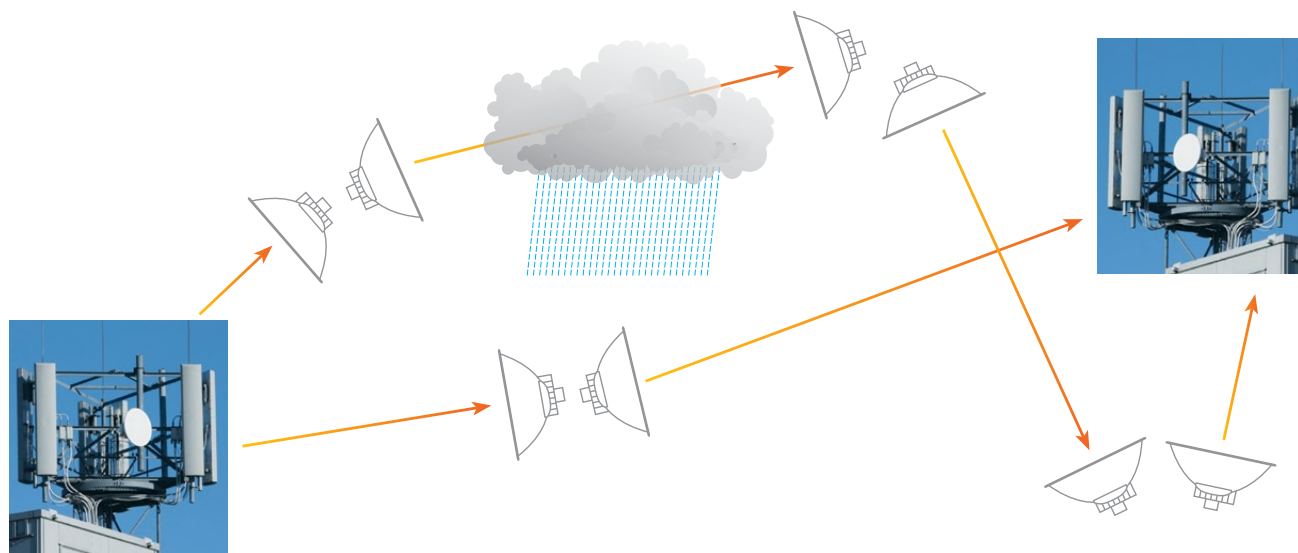

8.14: Network topology with dynamic routing paths

Fog

Fog presents a challenge only to the highest frequency microwave bands (above 60 GHz). Unlike rain, snow and other precipitation, fog presents no real obstacle to lower and more commonly used microwave frequencies.

Temperature

By itself, temperature has little effect on microwave signals. However, if water vapor is present in transmission lines, it can condense and impede performance when the temperature drops. The effect is similar to the attenuation caused by rain.

Snow and ice accumulation

Antennas must be designed to withstand accumulations of snow and ice (Figure 8.15) without deflecting or becoming misaligned. Fabric radomes on long-haul antennas prevent ice buildup that could otherwise impede the signal path; however, antennas are still vulnerable to damage from ice falling from higher up the tower and causing physical damage to the antennas. Ice shields fitted above the antenna offer robust, low-cost protection.

Wind load

The force of wind on an antenna (wind loading) can present a serious threat to tower-mounted equipment and the tower itself. Wind speeds rise with altitude, so a breeze at ground level can become a gale at the top of a tall tower or building. This is why antennas are designed to ensure mechanical integrity under all anticipated environmental conditions—up to their survival rating. In the case of CommScope's Class 3 ValuLine® antennas and Class 4 Sentinel antennas, survival rating is a minimum of 200 km/h (125 mph) or 250 km/h (155 mph).

Antennas also have an operational wind speed limit. It compares the antenna's allowed deflection under wind loading to its beam width. This ensures that link performance can be maintained so long as the wind speed does not exceed the antenna's operational wind speed limit.

Lightning strikes

Installed in open, unobstructed locations, microwave antenna towers are natural targets for lightning strikes. A direct strike to the antenna would cause serious damage to sensitive components. To avoid this danger, low-resistance earth-paths—in effect, lightning rods—are installed to direct lightning strikes away from critical components. For a full exploration of how to guard against lightning, see Chapter 11.

Radome

A wind- and water-proofed fabric or plastic cover that protects an antenna from the elements.



8.15: Ice accumulation on a radome-protected installation

Atmospheric effects

The atmosphere itself can also disrupt reception. This typically occurs at higher microwave frequencies where RF signals can be absorbed or attenuated by atmospheric gases such as oxygen and water vapor.

Under some circumstances, a signal may essentially be received twice—first by its intended LOS connection and then again as a slightly delayed echo of itself—a result of atmospheric refraction or ground reflection. The tiny timing difference can mean the signal arrives out of phase, in effect interfering with itself. This effect is known as “multipath fading” or “dispersive fading,” as illustrated in Figure 8.16. There are several ways to deal with this challenge.

Option 1: Space diversity. To counter the effects of dispersive fading, we can add a second, uncorrelated parallel microwave transmission path, separated vertically (Figure 8.17) or horizontally. This separation is called “space diversity.” Because the two paths don’t share the exact same space, their signals don’t encounter the same exact fading effects. The practical result is that the receiver has the option of accepting its signal from the path that is less disrupted at the time.

Option 2: Frequency diversity. Frequency diversity is another means of combating atmospheric or dispersive signal loss. A secondary, standby channel operates at a different frequency from the main channel. Since different frequencies propagate differently, two signals of different frequencies don’t experience the same attenuation—doubling the chances of clear reception.

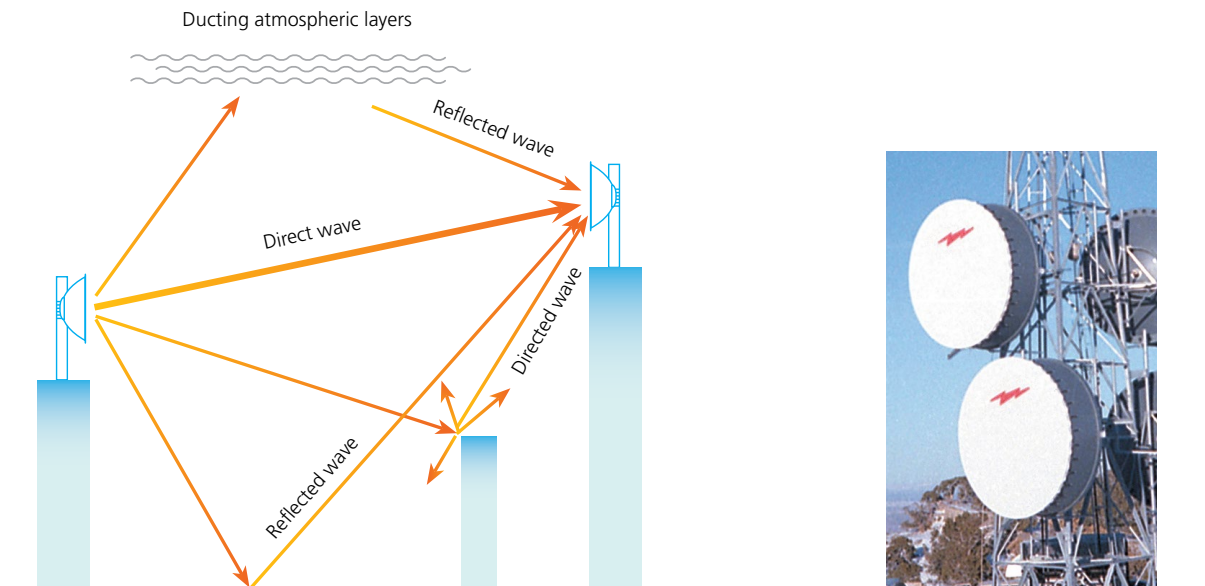

8.16: Dispersive fading creating out-of-phase signal echoes—delayed signals bounce off the ground and vertical obstacles, and also refract in the atmosphere

8.17: A typical vertical space diversity arrangement

Flat fading

Flat fading is another atmospheric hazard for low-frequency signals. Unlike dispersive fading, the entire channel is attenuated because refraction has disrupted the link's LOS connection, so it misses the receiver entirely. Using a second, uncorrelated microwave path or increased power via ATPC can counter this effect.

The importance of compliance

Some of the factors limiting the reliability of a microwave link can be avoided by using standards-compliant antennas from a reputable manufacturer. With the pressure to minimize total cost of ownership, it is tempting to purchase the lowest price antenna, but you must also consider ongoing operations expenses in budget calculations. An inexpensive antenna may end up costing far more than a more expensive one that offers better characteristics for your application.

Noncompliant antennas may also introduce design problems that can spell trouble from day one (Figure 8.18). Some of the more common issues of noncompliant antennas are that they are often:

- Untested and feature nonrepeatable designs
- Prone to deteriorate too quickly, resulting in RF leakage, moisture ingress and metallic components degradation
- Used with third-party add-ons for normal operation, which introduce new opportunities for corrosion, vibration and other loss of integrity



8.18: Example of RF leakage in a noncompliant microwave antenna

Flat fading

Total signal loss caused by atmospheric refraction. It is the result of a signal being bent completely out of its LOS connection with its receiver.

The hidden costs of noncompliant antennas

CommScope recently conducted a study to measure the cost and benefits of using lower-quality, noncompliant antennas. In this study, we examined three types in the 15, 18 and 23 GHz bands. In actual operation, the true costs began to emerge:

- Network failure of 19 percent in the 15 GHz band
- Network failure of 29 percent in the 18 GHz band
- Network failure of 21 percent in the 23 GHz band

Obviously, these failure rates are unacceptable for most applications. Choosing a compliant antenna— even a more expensive one—offers benefits that can save money and hassles once the antennas are in operation. The value of reduced interference, longer links, reduced tower weight and wind loads, more capacity and more efficient spectrum reuse is significant. These benefits are all particularly pronounced in ETSI Class 4 solutions such as CommScope's Sentinel solutions.

To ensure your microwave antennas meet specifications and your backhaul network performs as expected, there are common-sense steps you can take to avoid noncompliant antennas.

- Put the burden of proof on your supplier to demonstrate the structural integrity of the antenna under all anticipated environmental conditions.
- Review the supplier's antenna interface design data and test range facilities for each integration type.
- Avoid third-party add-ons that don't qualify at the integration level; the third-party supplier won't have this information, but your antenna supplier should.

This basic due diligence will pay off in reliability, speed and a lower total cost of ownership over the long term.



The techniques of tomorrow

In addition to high-performance fiber-optic and microwave backhaul technologies that make C-RAN possible, there are other exciting technologies waiting in the wings. Non-line-of-sight (NLOS) schemes using unlicensed bands offer one method of small-cell backhaul—allowing signals to turn corners and avoid obstacles in urban environments where LOS systems are far less effective.

The deployment of E-band spectrum (71–76 GHz and 81–86 GHz) has opened new avenues for high-capacity microwave backhaul. Operating under varying licensing regimes (depending on the country in which they are deployed), very wide channel assignments ($n \times 250$ MHz) are available to operators—making multi-Gbps data rates a real possibility. Combining E-band technology with conventional lower frequency microwave bands into a dual-band solution can provide very high-capacity, reliable links over a significant distance.

There also may be promise in the recently opened 60 GHz unlicensed band. At such high frequencies, the oxygen in the free air space itself can absorb signal power, making this band suitable only for short links—often less than a kilometer. Far from a limitation, however, the limited range is an advantage in urban environments where

the short-link option enables high data rates and low interference as signals move from one pico cell or micro cell to another.

With so many advances in recent years—and so many still to come—this is truly an exciting time in communications.

Backhaul makes modern communications possible

The ever-increasing complexity of modern communication networks demands more efficient and innovative ways of managing backhaul. Both fiber-optic and microwave technologies offer solutions with exceptional capacity, speed and reliability.

Backhaul is evolving to embrace fronthaul functionality as centralized RAN gains adoption and will support the cloud RAN deployments of the near future. This can be achieved mainly through fiber but also through high-capacity microwave.

At the same time, microwave backhaul is evolving to meet higher standards—with lower sidelobes, tighter RPEs and better interference discrimination. This maximizes the uses of existing spectrum and allows ever denser networks to be deployed. Plus, the availability of new spectrum for use in these applications means microwave backhaul will only grow as a powerful tool for the latest and next generation of cellular communications.

The key takeaway is that fiber-optic and microwave backhaul solutions are complementary, not competitive, technologies. Any large-scale network will need to employ both—fiber-optic for its vast capacity, and microwave for its flexibility in remote or cost-limited areas. Together, they can provide the wide pipeline needed by today's most advanced wireless networks.

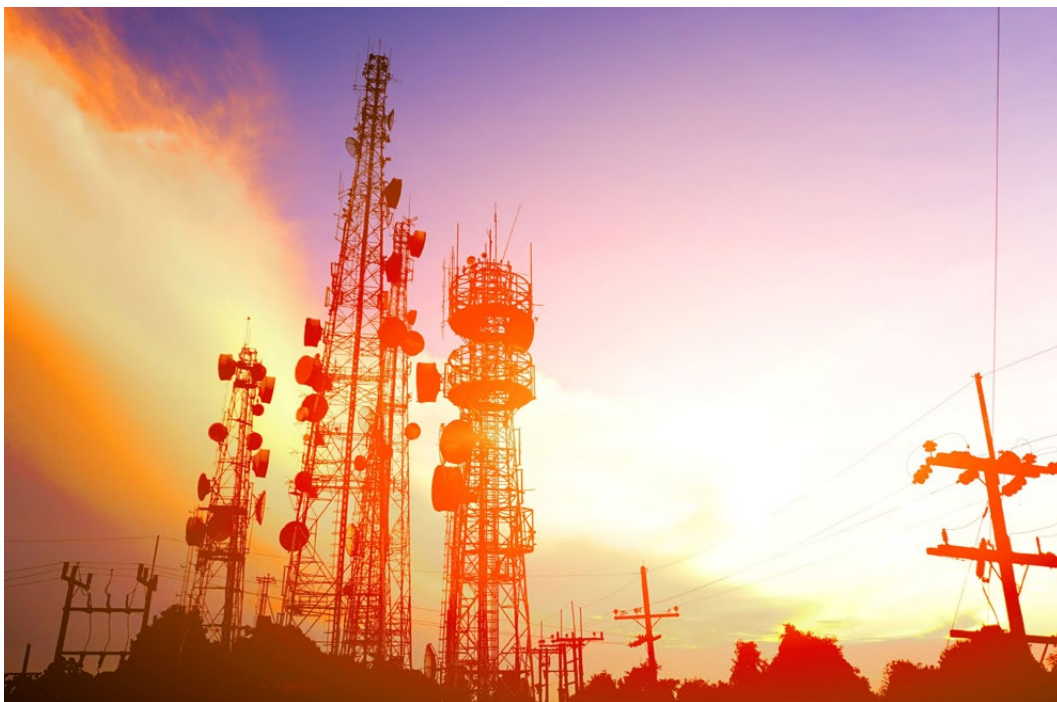

Chapter 8 summary

- Backhaul moves traffic on and off the core network.
- This is most commonly accomplished with fiber-optic cable or microwave antennas.
- Fiber-optic alternatives are efficient and open the door for new architectures.
- Centralized RAN uses fiber-optic cable to move baseband units from multiple sites to a shared central location.
- Cloud RAN will virtualize baseband functions in data centers for even more flexibility and efficiency.
- Microwave antennas use LOS to link sites to the core network affordably and flexibly.
- To overcome environmental challenges, there are many practices and solutions available for microwave backhaul antennas.
- Class 4 options offer improved efficiency, capacity and reliability.
- Noncompliant antennas are subject to reduced performance and more interference.
- New microwave technologies are emerging to expand backhaul capacities.



Chapter 9

The next RF architecture evolution: C-RAN

Thus far, many of the recent RF network innovations described in this eBook relate to more efficient transport of signal and/or power; improving coverage and capacity; or expanding the RF network in a practical, cost-effective manner. However, there is another innovation poised to revolutionize the very architecture of RF networks—C-RAN, or centralized radio access networks.

We discussed C-RAN briefly in the last chapter. But, due to its game-changing potential, it deserves a closer look. Before defining what C-RAN is, let's first define the conventional architecture of modern RF networks; then, it will be easier to see how C-RAN changes that model. We can also look ahead to the next stage beyond centralized radio access networks into the emerging realities of cloud radio access networks—which, confusingly enough, are also known by the shorthand term “C-RAN.”

Distributed radio access networks (D-RAN): status quo

What most would consider a “conventional” modern RF network architecture. In general, it features antennas and radios connected to baseband units (BBUs), with all RF equipment located at the cell site. BBUs then connect to the core network via fiber-optic or microwave radio backhaul—allowing traffic to switch and move freely from any point on the network to any other point. Figure 9.1 provides a basic schematic of this design.

The D-RAN architecture has served mobile operators well for the past 30 years and more. But the world is not the same as it was when the first commercial D-RAN networks were being rolled out en masse in the 1990s. The global appetite for mobile services has skyrocketed since then. In addition to building out more network capacity, network owners are also looking to better control operations and maintenance costs at an increasing number of mobile sites.

At the same time, there has been a tremendous shift in global consciousness regarding the environment and the existential threat of climate change. This has led governments, NGOs and businesses communities—including mobile network providers—to rethink “business as usual” and how we can reduce greenhouse gas emissions, heavy metal extraction, and our reliance on fossil fuels, single-use plastics, etc.

Centralized radio access network (C-RAN)

A wireless network architecture that separates a site's antenna and radio from its baseband unit (BBU) by relocating and pooling BBUs from multiple sites at a single centralized off-site location where they can be more easily managed. BBUs connect to their respective sites predominantly via fiber-optic fronthaul.

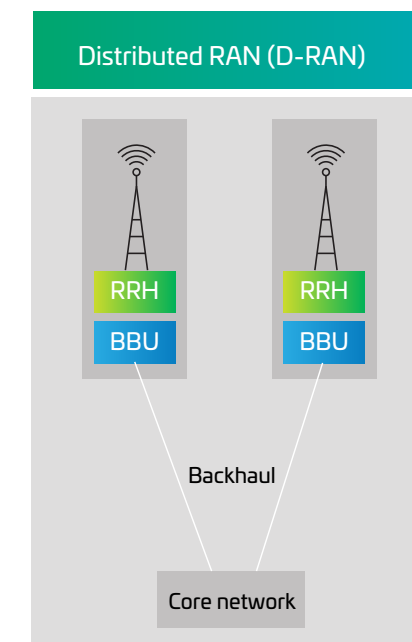

9.1: Distributed RAN

These large global trends have coincided with exciting technology breakthroughs in mobile network designs. Such advances include next-generation fiber-optic transmission to enable ultra-low latency fronthaul and backhaul, the emergence of network function virtualization and the continued disaggregation of network components (remote radio heads, for example).

Centralized RAN and beyond

The result of these trends and changes has been a radical reimagining of mobile network architecture, which has opened exciting new opportunities for operators to significantly reduce cost, improve the user experience and address the threat of global warming.

The basic architecture, shown in Figure 9.2, represents a significant departure from a traditional distributed RAN model. It moves the BBUs from multiple individual cell sites to a centralized location, sometimes referred to as a BBU hotel, which can be located several miles from the sites being served. Meanwhile, the antennas and radios remain on-site and connect to their respective BBUs via fiber-optic cables. BBUs in each hotel connect back to the network core via fiber or microwave backhaul.

The beauty of this design is that the wireless operator can now co-locate baseband units from many sites in a single centralized location. The design saves cost and makes maintaining and operating the BBUs easier and more efficient.

Key advantages of C-RAN

C-RAN is an attractive network architecture for wireless operators for several reasons, all related to the performance of the network and the cost of operating that network.

Efficiency

C-RAN deployments require less equipment at individual cell sites. In addition to saving on hardware costs, the C-RAN model can create savings in terms of power, cooling and site leasing costs. By locating BBUs in a single, secure and controllable location,

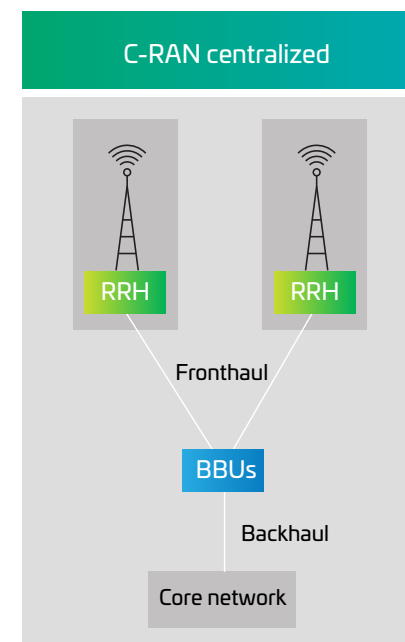

9.2: Centralized RAN



COST

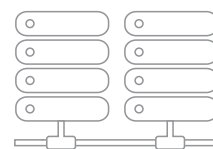

POOLING

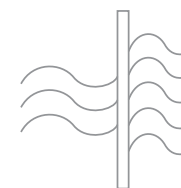

REPURPOSING

operators improve their CapEx. Reducing on-site network requirements, in turn, reduces space leasing costs and power consumption—helping minimize ongoing OpEx.

The bottom line is, it's more cost-efficient to maintain a pool of BBU hardware in one location than to service them spread across dozens or hundreds of distributed sites.

Performance

C-RAN also offers wireless operators a significant advantage in terms of how their network's capacity is utilized. Because BBU functions are pooled in a single location, it becomes possible for them to share and balance traffic loads across the network. As demand shifts from one location to another, BBUs can help each other process the load, ensuring that operators are getting the best performance (and value) from their infrastructure.

C-RAN also enables multiple cell sites to handle the same signal at the same time, essentially “repurposing” the interference that would normally occur. This capability, known as “advanced coordinated multipoint (CoMP) send and receive,” uses a complex software algorithm to pool signals from multiple antennas—creating additional capacity where intercell interference would otherwise occur. It is made possible by the extremely low latency times afforded by high-speed fiber fronthaul.

Sustainability

It's currently estimated that telcos are responsible for 1.6–3.9 percent of global GHG emissions;¹ without immediate action, this figure will continue to grow. In order to keep in line with the Paris Agreement, telcos must reduce their emissions by 45% before 2030, or risk contributing to the irreversible effects of climate change.² Centralized RAN and its potential successor, cloud RAN (see below), enable network operators to continue progressing toward net zero emissions. Reducing the amount of baseband processing equipment needed across the network effectively removes mined materials and the environmental impacts of converting them from raw materials to finished products.

At the same time, centralizing equipment in BBU hotels as opposed to maintaining individual baseband solutions at each cell site reduces the network's overall cooling and power requirements. It also enables service teams to make a single trip to a BBU hotel in order to service, upgrade or repair multiple baseband units—reducing fuel consumption and CO₂ emissions.

Advanced coordinated multipoint (CoMP) send and receive

The process by which signals from multiple antennas are pooled to create additional capacity where interference would otherwise occur.

Going beyond C-RAN

As attractive as C-RAN is for many deployments, some view it as just a stepping stone to an even more efficient architecture—cloud RAN, a.k.a. virtual RAN (vRAN).

Cloud RAN (Figure 9.3) takes the C-RAN concept to the next level. Here, selected network functions are virtualized in a cloud infrastructure, essentially replacing much of the costly and specialized baseband processing equipment with commercial off-the-shelf servers. Although the virtualized BBU functions could still reside on site, the larger benefits are achieved when the workloads are executed in centralized locations that can serve tens or

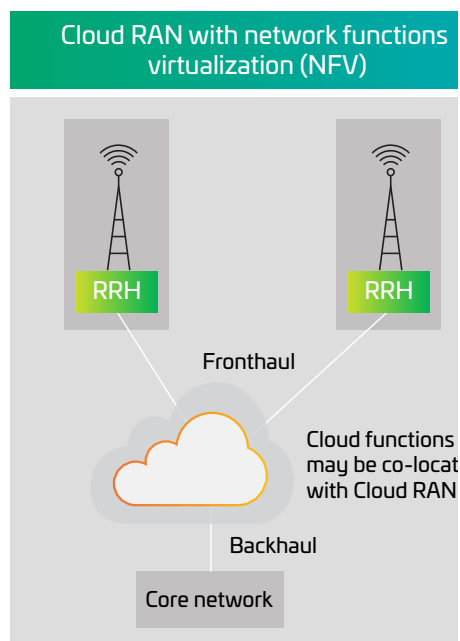

9.3: Cloud RAN

hundreds of sites. Centralizing base station processing with cloud-based RAN or vRAN simplifies network management and enables resource pooling and coordination of radio resources.

Why C-RAN—and why now?

The arrival of C-RAN (and the promise of cloud RAN) couldn't have come at a better time. As demand for wireless services continues to break records, operators face tremendous cost pressures. To satisfy the growing demand, they must expand their network footprint and capacity; yet, at the same time, average revenue per user (ARPU) shrinks year after year. With few options to increase subscriber revenue, operators must look to reduce costs if they are to improve profitability.

Current trends point to increased utilization of C-RAN as operators densify their networks and roll out small cells—especially in densely-populated areas. Yet small cell deployments are notoriously regulated, subject to some of the most stringent municipal zoning laws. C-RAN can help mitigate these issues as centralizing and sharing baseband processing equipment reduces the number of BBUs and aesthetic concerns. The centralized approach also has the added benefit of reducing the cooling requirements.

C-RAN also makes it easier for operators to deploy smaller, more zoning-friendly sites that operate on lower power than large macro sites.

Blurring of networks—and expectations

Modern wireless subscribers see little distinction between the networks they use at home, in the office, and on their mobile devices. They expect a seamless and speedy internet onramp from their phones, laptops and desktops. C-RAN helps make this possible.

The challenges of C-RAN

As with every innovation described in this eBook, C-RAN faces some considerable challenges in its deployment as a practical solution. None are insurmountable, but they can alter the calculus involved in deciding where and when to deploy C-RAN architecture in a wireless network.



Fiber-optic fronthaul requirements

Owing to the enormous amount of bandwidth required by current-generation LTE/5G networks, the fiber-optic fronthaul infrastructure linking a site's radios to the remote BBU must meet high performance standards. 10 Gbps speed is required, often as a minimum, along with extremely low latency. For many operators, this means adding or upgrading existing fiber-optic installations, which means boosting their investment in fiber infrastructure.



Reliable baseband interconnectivity

Pooling multiple BBUs in a centralized location can also introduce vulnerability in the network. In the event a BBU unit (or multiple BBU units) fails, the C-RAN hub itself must be equipped with a high-speed, low-latency fiber-optic switching infrastructure. Without this, a failure in one unit could not be efficiently compensated by other units. It's also important that the hub's switching network provides the flexibility and scalability to grow and adapt as the network's needs change over time.



Advanced coordinated multipoint (CoMP) transmission and reception

Described above as a means to reduce interference between cells and improve network capacity, CoMP send and receive requires an advanced interface between BBUs and the capacity to jointly schedule radio resources. This requires BBUs capable of providing the throughput speed and low-latency performance needed to process channel information and end-user data in near-real time. It also means the backhaul at the other end must deliver equally fast, low-latency performance.



Hub locations

Finding the best location for a C-RAN hub (Figure 9.4) can be something of a balancing act. Placing it closer to the network core enables you to consolidate more sites. On the other hand, placing it closer to the edge could help you better utilize and repurpose existing facilities. Additionally, available space is getting harder to find. In many dense urban environments, the ideal location may be difficult or impossible to secure.

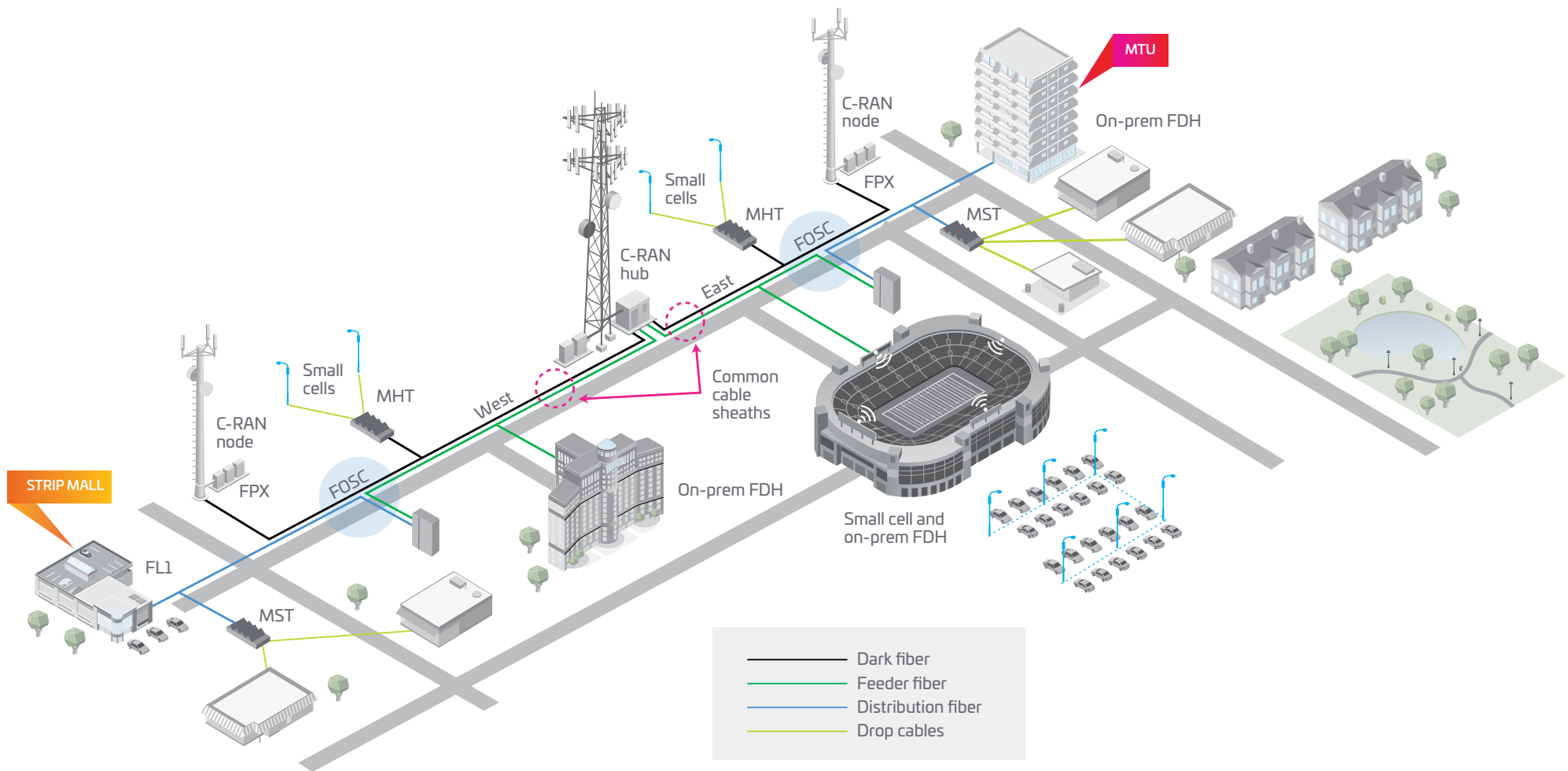

9.4: A single centralized RAN hub (center) manages traffic from multiple locations across a city

Welcome to the age of C-RAN

C-RAN is among the most exciting developments in the wireless industry over the past 20 years. It represents a radical, fundamental re-imagining of the way wireless networks are designed and built—a necessity considering how we are constantly re-imagining what we expect our wireless networks to do.

Both in its centralized and cloud-based implementations, C-RAN will answer operators' calls for a more efficient, more powerful network at a time when subscriber expectations far exceed their potential incremental revenue value.

In this way, C-RAN represents as fundamental a change to the business model of the wireless industry as it does to its architecture.

C-RAN is indeed the network of the future—and it's already here.

¹ The real climate and transformative impact of ICT: A critique of estimates, trends, and regulations; Science Direct, journal article; 10 September 2021

² ICT industry to reduce greenhouse gas emissions by 45 percent by 2030; ITU, press release; 27 February 2022

Chapter 9 summary

- Centralized RAN relocates multiple BBUs from their individual cells sites to centralized locations whose fronthaul connects back to each site via high-speed, low-latency fiber.
- Cloud RAN virtualizes BBU functionality in the cloud, allowing virtualization of BBU operations.
- Co-located BBUs, whether C-RAN or cloud RAN, are more efficient to operate, cool and maintain.
- Benefits include greater efficiency, load sharing and reduced environmental impact, as well as the possibility of improved user QoS.
- Challenges to C-RAN deployment include fiber fronthaul capacity; hub location and infrastructure; and advanced CoMP send and receive interfaces.

A hand is shown in the center, reaching out towards a glowing digital network of binary code (0s and 1s) and energy lines. The background is a gradient of green and blue, with a bright light source on the right side. The overall theme is technology and communication.

Chapter 10

The energy of communications: Powering wireless networks

Every year, our reliance on always-on technology grows. We expect to be able to place a call or surf the internet with our cell phones at any time, under any circumstances. However, the electrical infrastructure that powers our wireless networks has not kept pace with the demand for more macro cells and small cells. The challenge goes deeper than powering additional cell sites. The architectures of cellular access are changing dramatically. Customer demand is pushing 5G rollouts which, in turn, require more RF equipment. Additional radios, more frequencies and increasing use of remote radio units, plus an entire small cell layer that still needs to be built out are pushing outdated power systems to the brink.

What's at stake from a business perspective? Plenty. A reliable power infrastructure has significant implications for both cost and revenue. Running power to thousands of small cells will be expensive. Cutting cost by even a point or two can generate major savings, as can reducing

deployment times by a day or two. On the revenue side, we know the effect that network outages have on churn rates. With the vast majority of cell sites relying on older power grids for primary power, the need for reliable backup power is more important than ever.



Powering today's macro site

Site architectures are quickly changing, with more active and passive RF components being moved to the top of the tower. This shift is affecting tower loads and creating additional congestion at the top. Bringing power to a network's macro sites is the biggest challenge, literally and figuratively. So, let's dive in.

Power types—DC vs. AC

The core technology that drives modern communications runs on direct current (DC) electricity, as opposed to the alternating current (AC) that powers our homes and offices. But the electrical power sent across transmission lines from power plants to the cell site is AC. Before it can be used to power the on-site equipment, AC power must be converted to DC using a rectifier. The rectifiers' output is fed to the radio and RF transmission equipment—the current “load”—and the backup battery equipment (Figure 10.1).

This begs the question: If the power mains feed is AC, why is the cellular equipment designed to operate off DC? There are several reasons.

First, most communications equipment includes semiconductors and other integrated circuitry that are designed to operate specifically with DC, such as:

- Telephone switches
- Microwave transmitters
- Fiber-optic transmitters
- Mobile radio and cellular systems

Another reason DC power is preferred for communications systems is reliability. Even the most advanced electrical grid can fail from time to time, and power interruptions may last for hours or days. When the outage occurs at a cell station, shutting down is not an option. So, cell sites rely on battery backup and generators to augment the rectifier plant and ensure continuous operation. And, you guessed it, the battery backups and generators are both DC.

Volt (V)

A measure of electric potential difference between two points in a path. Voltage is sometimes referred to as “pressure” because it shares many characteristics with pressure in a water pipe.

Direct current (DC)

An electrical current that runs continuously in a single direction, making it well suited for use in motors and electronic components such as semiconductors. Batteries also produce DC current.

Alternating current (AC)

An electrical current that changes polarity (direction) 50 to 60 times per second. It offers significant efficiencies when transmitted across power lines—making it the standard current for household use.

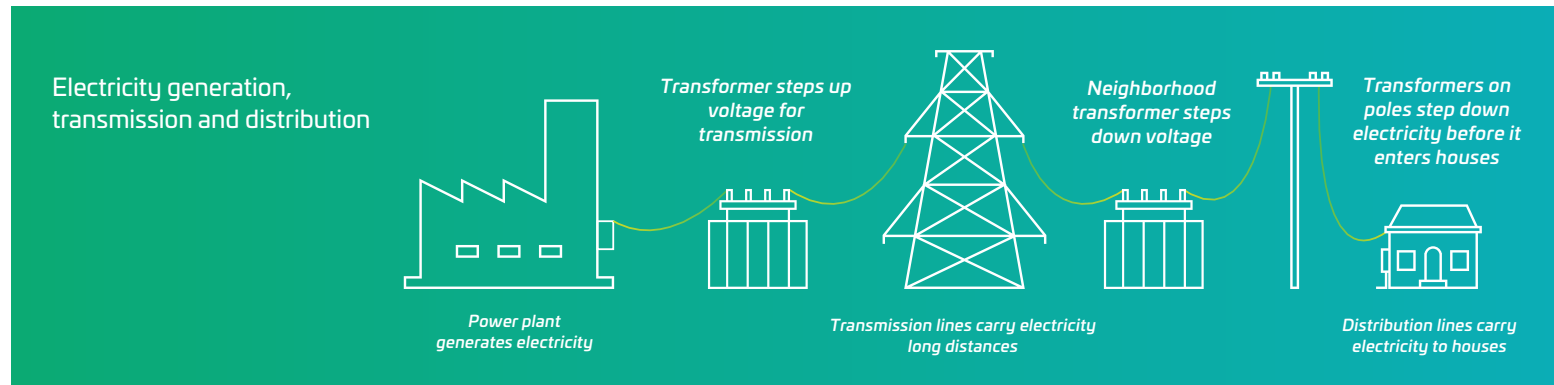

10.1: Electricity generation, transmission and distribution

Source: adapted from National Energy Education Development Project (public domain)

DC power by the numbers

Communication equipment requires specific voltages of DC power. Most commonly, the requirements are positive 24 volts (+24 V) and negative 48 volts (−48 V). The higher −48 V value reduces associated current—enabling the use of smaller and less expensive fuses, circuit breakers and cables. Therefore, −48 V has become the dominant power supply voltage for communication equipment.

Going beyond the basics

As mentioned above, the basic core components of a communication system's power connection are the rectifier (which converts AC power to usable DC power) and the batteries (which assume the load when external power is interrupted). Once DC is online, however, we must consider the specific power needs, or loads, of different equipment and have a way to distribute the correct voltages to each piece of equipment. This is where DC-DC converters come into play.

DC-DC converters modify the primary DC voltage to suit the varying voltage needs of the equipment. For equipment requiring AC current, an inverter is used to change DC back to AC. Because this happens behind the station's main rectifier, the reconverted AC power isn't subject to interruptions from the external power supply. A sample diagram showing all these components appears in Figure 10.2.

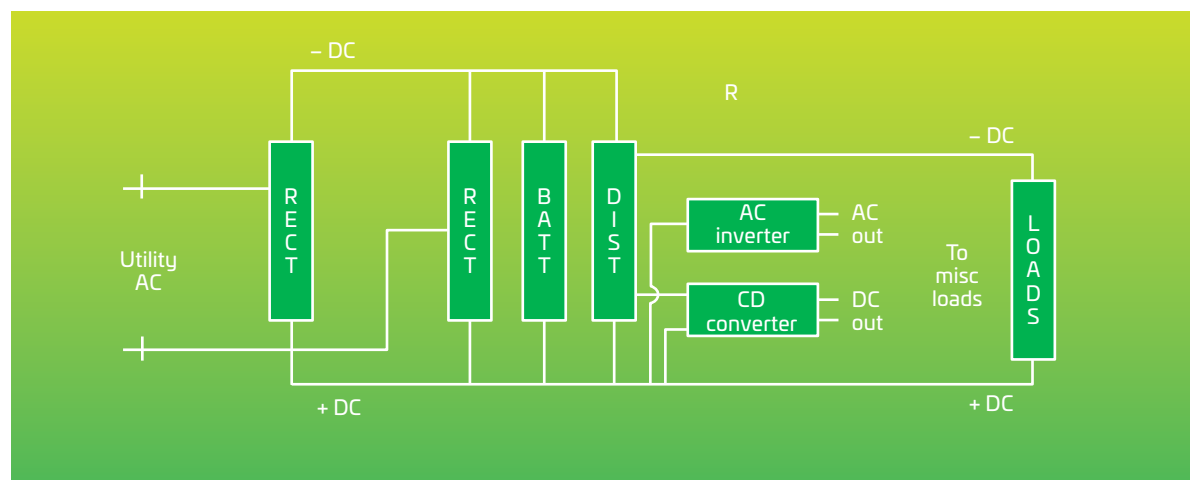

10.2: A block diagram of a basic telecommunications power system

The chemistry of batteries

At its most basic level, a battery is an electro-chemical device that stores and releases electrical energy. A battery contains chemicals that react with one another, producing DC electrical current as a byproduct. The specific chemicals and processes may vary—we will examine some common varieties below—but, on a fundamental level, all batteries operate on this core principle.

Cell site battery backup requirements usually range from two to eight hours, depending on the load. Since telecommunications providers must be able to specify expected operational times, choosing the best type and configuration of batteries is critical. So, what are your options?

- **Lead-acid batteries**

These are commonly used as backups for telecom power systems. They are compact relative to their output and are similar to the battery under the hood of your car. They are available in vented and valve-regulated forms.

- **Vented** (also known as **wet** or flooded) **batteries** are a mainstay of telecom central offices and switching centers. They can maintain a charge for 20 years or longer.



However, they demand a great deal of costly maintenance, such as water treatment, spill containment and forced-air ventilation. These drawbacks make them less suited to remote cell base stations.

- **Valve-regulated lead acid (VRLAs) batteries** are relatively new for wireless telecom applications. Unlike VRLA batteries, which are composed of four 12 V DC batteries per string, lithium-ion batteries are packaged in a single rack-mounted module that provides –48 V DC output. These batteries are highly compact (50 percent of the volume of a comparable VRLA battery).

- **Lithium-ion batteries** are relatively new for wireless telecom applications. Unlike VRLA batteries, which are composed of four 12 V DC batteries per string, lithium-ion batteries are packaged in a single rack-mounted module that provides –48 V DC output (Figure 10.3). These batteries are highly compact (50 percent of the volume of a comparable VRLA battery).

The arrangement of these batteries in series determines the voltage polarity. If each of the 12 V batteries is rated for 100 amp-hours, then each series string could be expected to produce 100 amps of current for one hour. Capacity is directly related to the size of the battery but, rather than spending more on larger batteries, we can achieve the same capacity boost by adding more battery strings in parallel as opposed to in series. This option also safeguards against the failure of an individual battery, which would otherwise remove its string from

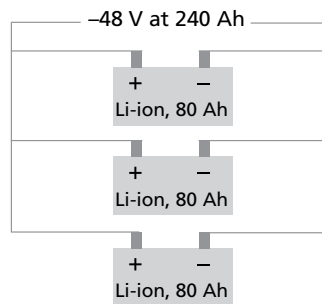

10.3: VRLA lithium-ion batteries configured in series for –48 V applications

the system altogether. By connecting in parallel, the spare capacity is already online and ready to maintain the current for its rated length of time. A diagram of sample parallel battery strings rated at 240 amp-hours appears in Figure 10.4. Note that, if a battery fails in any of the three series strings, the remaining two strings will continue to supply steady power at 160 amp-hours.

This configuration also provides a convenient means of maintaining the batteries. Often, these strings will be installed with separate disconnection breakers—making it easier to locate failures and isolate problems that could otherwise cripple the entire system.

Lithium-ion batteries are packaged in rack-mounted –48 V DC modules in parallel. Should an individual module fail, the remaining modules will continue to provide backup power.

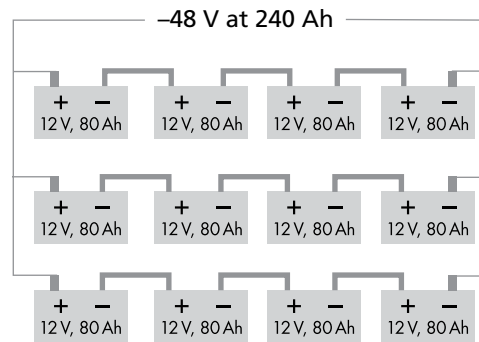

10.4: A VRLA multi-string battery configuration offering additional redundancy

Voltage polarity: positive (+) and negative (–) voltage

The + and – designations of +24 V and –48 V refer to which polarity of the battery circuit is measured; in terms of actual power produced, the distinction is meaningless.

Generators: the first line of defense

If batteries are the last line of defense against service interruption, generators are the first. Since batteries alone can maintain operations for only a few hours, longer AC service interruptions require a longer-term solution—and that means generating our own power. Unlike batteries, generators provide power by burning fuel. Like batteries, there are different types and configurations available. Which one you install depends on factors like space, cost and service expectations.

Since they operate outside the base station's internal DC system, generators aren't considered part of that system. Because they supply the DC system's rectifiers with the AC they need, however, they're a vital link in assuring reliable operation. In the event the station must switch from external power to generator-supplied power, an electrical device called a "transfer switch" shunts the load to the generator, such as the one shown in Figure 10.5.



10.5: AC permanent generator

Rectifiers: the AC-DC interface

Once we move beyond the external source of power—whether commercial AC service or an AC generator—the rectifier is the core of the system’s DC power distribution needs.

The rectifier provides an output DC voltage level that maintains the battery charge. This level is called “float voltage,” and it supplies the equipment load as well as a trickle charge to the battery. When AC power is interrupted, the rectifiers go offline and the batteries automatically kick in to provide the required level of

power to the rest of the system. When external AC power is restored, the rectifiers re-engage, and the batteries return to their trickle-charging state (Figure 10.6).

Typically, multiple rectifier modules are required to supply power for the station’s load. Rectifier modules are connected in parallel, letting each one share an equal part of the load—a practice known as “load sharing.” With load sharing, operators can incorporate redundancy into the design to guard against individual rectifier module failures.

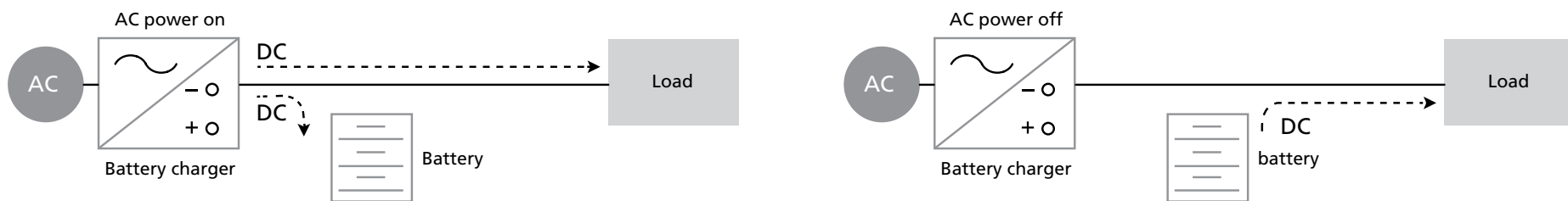

10.6: External AC power on (float mode) and off (discharge mode)

Choosing the right rectifier

The first consideration in deciding which rectifier will best suit a given installation is the type of AC power it will receive. Switchmode rectifiers (Figure 10.7) are the preferred choice for cell and microwave sites since they can support multiple AC inputs and have a broader operating range—from single-phase to three-phase inputs. This flexibility means fewer rectifiers are required—saving money, space and maintenance costs.

Your choices impact more than your network

When designing and deploying a macro site, every choice has an impact that goes beyond the network. For example, selecting switchmode rectifiers not only reduces your CapEx and OpEx, but it also reduces your embodied carbon by reducing the number of rectifiers needed, along with the CO₂ they emit when operating. Think about it.



83A switchmode
6.3 in H x 3.4 in W x 11.8 in D

10.7: A typical switchmode rectifier

Distributing the power

Once power is converted by the rectifier, it must be distributed to the many component loads within the system. As mentioned, these loads include core elements like the radio, transmitter and battery backup, as well as secondary systems like lighting, security networks and HVAC systems (Figure 10.8). In the most complex installations, there may be so many components that up to 80 circuit breakers are required to manage them.

Redundancy = reliability

For a -48 V application with 200 amps of load, an operator may choose to install five 50-amp rectifiers. Why add a fifth, when four would provide the requisite 200 amps? To ensure N+1 redundancy. Arranging multiple rectifiers in parallel allows load sharing to even out and shift the load.

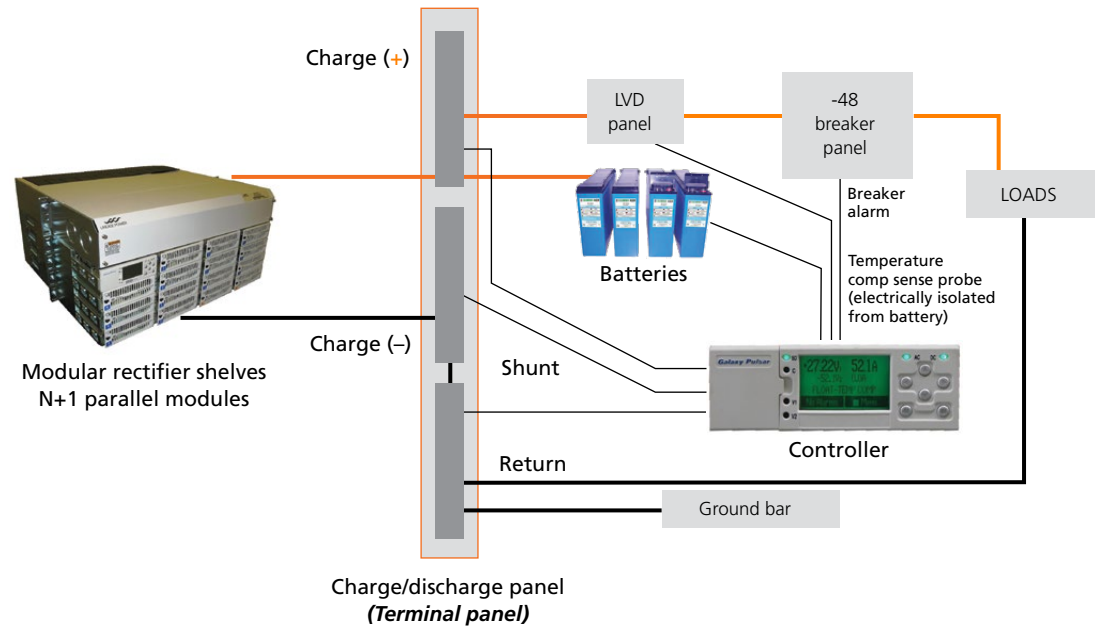

10.8: A diagram of a typical -48 V DC power distribution system (Images and illustration courtesy of GE)

Fuses vs. circuit breakers

While both fuses and breakers provide overcurrent protection, they do it in different ways. Fuses are designed to melt under unsafe currents—physically breaking the connection between the power source and the load. Circuit breakers have internal switches that pop to the “off” position under unsafe conditions—again providing a physical break in the circuit.

Sensitive wireless equipment requires “fast blow” fuses or short delay curve breakers to provide the needed protection. Fuses are generally used for lower loads and offer the advantages of lower cost, greater flexibility and fast action. Circuit breakers are preferred for larger loads and do not require replacement every time they are tripped. Some typical examples are shown (Figure 10.9).



10.9: Common types of telecom fuses and circuit breakers

Surge protection

Typical variations in AC power are not the only threat to a cell site. Electrical events like lightning can also produce excessive voltages and currents—“electrical surges.” Surge protection devices (SPDs) are incorporated to reduce the effects of these surges on sensitive electronics (Figure 10.10).

An SPD features a non-linear voltage-current characteristic that reduces unsafe voltages by increasing the conducted

current. In this case, a cell site’s SPD operates on the same principle a surge protector does in your home—safeguarding expensive electronics from lightning-induced surges.



10.10: Typical surge protector devices (SPDs) (image courtesy of Raycap Corporation)

Bus bar conductors

The cell site's power distribution system is supported by the bus bar conductors, which physically connect the rectifiers to the batteries and DC loads. There are two bus bar connectors: the charge bus and battery return bus.

- The **charge bus** is a current-carrying conductor that connects the rectifier's output to the battery string. For instance, in a –48 V system the negative rectifier lead terminates on the charge bus along with the corresponding negative lead of the battery.
- The **battery return bus** provides a common return point for the loads connected to the power system. This common point is grounded to provide a low-impedance path for transients and noise and offers a ground reference to all connected equipment.

Battery disconnects

Battery disconnects are switches installed on a battery string that enable easy disconnection for maintenance or replacement. Some disconnects incorporate safety measures such as overcurrent fusing or breakers.

Load disconnects

Low-voltage disconnects (LVDs) are designed to respond to low-voltage conditions in the circuit. There are two types of LVDs typically used in cellular communications.

Low-voltage load disconnects (LVLDs) can disconnect individual loads, while low-voltage battery disconnects (LVBDs) can disconnect a fully discharged battery. LVDs serve three main protective functions:

1. Prevent damage to sensitive electronics caused by low-voltage (hence, high-current) conditions
2. Prevent permanent damage to the battery from over-discharging
3. Prioritize which components are disconnected, and in which order—preserving limited function when necessary

Supervision, monitoring and control

Modern telecommunication power plants are equipped with electronic monitoring and control systems, generally called controllers (Figure 10.11). They track system voltages, currents, temperatures and other key indicators. They also allow operators to make adjustments to the system from a central monitoring point—usually the distribution cabinet or in a rectifier slot located in the power plant. The controller enables technicians to monitor and adjust a wide range of system variables and processes. Here are just a few:

- **Plant control.** Control functions are extended from the supervisory panel to control other power system components. These panels communicate directly with

the rectifiers and, in some cases, can coordinate the sequenced restart of all rectifiers to prevent power surges during switchovers from external AC to a backup power source.

- **Manual equalizing.** This allows a user to simultaneously engage all rectifiers in equalize mode. This is useful for maintenance on VRLA batteries—equalizing cell voltage within a battery string.
- **High-voltage shutdown/overvoltage protection (HSVD/OVP).** Controllers can automatically shut down rectifiers when DC output overvoltage conditions are detected—avoiding costly damage to load components.
- **Low-voltage disconnect (LVD).** If a low-voltage condition is detected in the backup batteries, the controller can open additional contacts to equalize voltage and close them again when levels equalize.
- **Battery temperature compensation.** The controller can adjust rectifier output to meet the temperature-driven voltage needs of the batteries.
- **Charge current control.** This feature limits the current flow to a battery when it begins recharging after a power interruption. By keeping the battery from recharging too quickly, it prevents overheating and prolongs life.
- **Battery diagnostics.** The controller can estimate the “health” of the battery and predict how long it will provide power based on its charge status.
- **Alarm monitoring.** The controller monitors critical functions like distribution and battery fuse alarms, rectifier failures, converter failures and more. It uses network backhaul interfaces and LED indicators to report these alarms. Some units include audible alarms as well.
- **Status monitoring.** The controller can measure and compare the battery charge to the system load via an external shunt.
- **Plant history.** Controllers can log power system details over a span of time, including such statistics as thermal performance of outdoor enclosures, battery cell states or variations in AC input experienced by the rectifiers.



10.11: A system controller interface displaying voltage, amperage and alerts

DC-DC power conversion

Some wireless sites require multiple DC voltage outputs, such as +24 V DC and –48 V DC. While you could simply install a second rectifier plant, that would require a second battery backup array as well, which consumes considerable space and adds cost. Instead, many networks use a DC-DC converter system that changes one DC input voltage to a different DC output voltage.

A DC-DC converter system is actually multiple DC-DC converters arranged in parallel. It may also incorporate many of the same functions as the primary DC power system, such as distribution. Dedicated fuses or circuit breakers isolate it from the rest of the system.

Since a DC-DC converter system does not have an associated battery connected to its output, it isn't bound by a battery system's requirement for precise output voltage. However, since it is necessarily energized by the primary DC power system, that demand must be figured into the power system's initial design.

Pros and cons of converting voltage

Modern DC-DC converters are essentially “plug and play” devices designed to fit in the racks alongside rectifiers and other converters. This approach offers network operators the greatest flexibility in adopting next-generation technology—offering new services while maintaining older standards.

The disadvantage of converting to a given voltage is that it is inherently less efficient than drawing the voltage directly from the rectifiers. The more DC power that is converted away from the primary voltage, the greater the power signal loss.

Mapping the positions

Since a single power plant can generate varying amounts of primary and secondary voltages, we must be able to assign numbers to the distribution positions of each voltage. A selectable voltage distribution panel makes this organization possible.

Integrated power systems

So far, we have focused on the individual components that compose a cell site's power system. With so many components, you can imagine how quickly the available space inside the base station shelter or cabinet fills up. To address the space issues, CommScope engineers integrated power systems that combine multiple components into a single device that can be installed in a single rack.

A typical integrated cell site power system includes one or more shelves of rectifiers along with one or more shelves of DC-DC converters. This integrates power conversion and power distribution functions—connecting them with bus conductors. The distribution system contains an integrated DC bus, fuses or breakers and cabling tie-downs to distribute power to the load (Figure 10.12).

This approach not only enables network operators to conserve space, but—by eliminating the need to manufacture multiple components—it also reduces the environmental impacts such as the power consumed during production and the associated CO₂ emissions. The space-efficient design and reduced carbon footprint have helped make integrated power systems increasingly common in modern cell sites.

DC-AC inverters

As mentioned earlier, some of the equipment operating at a cell site may also require AC current from battery backup supplies. Since the entire system is built around DC power, a DC-AC inverter is needed to provide the necessary AC voltage (Figure 10.13). There are two basic types of inverters:

- **Offline inverters** feature an AC input and an AC output with a connection to a standby DC line available. This is the type generally used in cell site applications.
- **Online inverters** feature a DC input and an AC output with an optional AC standby line available.

Like DC-DC converters, the input for a DC-AC inverter is supplied by the primary power plant. Like converters and rectifiers, inverters are often installed and configured for redundancy. A static switch maintains equalized voltage to the load by automatically switching between external AC power and the inverter's AC power. The switching is instantaneous—assuring no interruption in operation.



Integrated power systems

Space-saving combinations of related components built into a single device for easy installation.

10.12: A DC-AC inverter system connected in series to a cell site's power system

AC power sourcing flexibility

As utility costs rise and public demand for greener options increases, network operators look to augment traditional utility power with power from renewable sources. To address this, some rectifiers are now able to accept AC power from attached solar panels or wind turbines

(Figure 10.13). This hybrid power solution is one way networks can begin to move toward a greener, cleaner operating model without completely overhauling their power management and distribution systems.

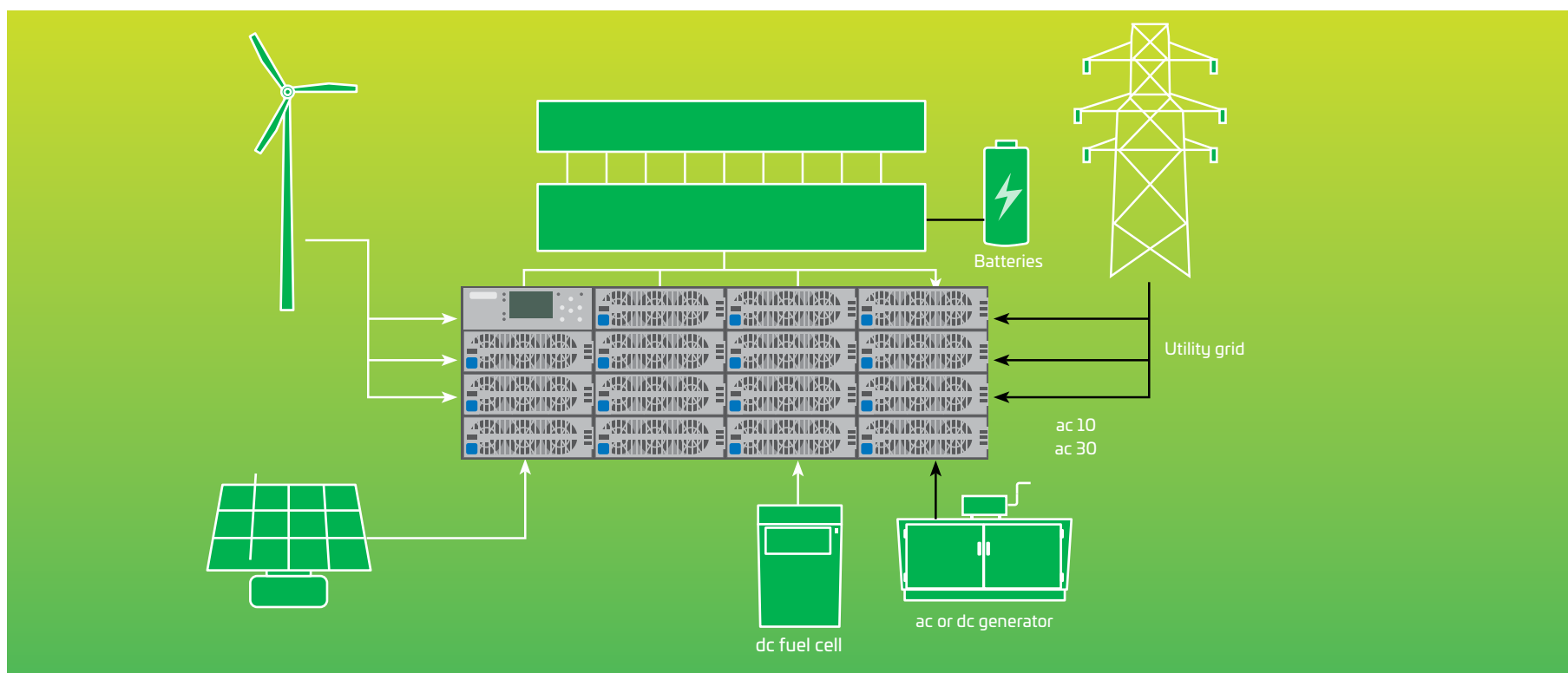

10.13: Power source flexibility lets rectifiers draw from conventional or renewable sources

Architectural improvements to power management

Significant RF power losses occur as the signal moves from the radio transmission equipment in the base station shelter to the antenna atop the tower. These losses are a natural consequence of traversing long stretches of coaxial cable. However, the simple architectural change of moving the radio's transmitter and amplifier—known collectively as the “radio head”—from the shelter to the tower eliminates these losses and reduces power requirements. This design is called the “remote radio head” (RRH). In an RRH deployment, the baseband equipment remains on the ground and is fed by external AC power that enters at the cabinet or shelter. Moving the radio transmitter and amplifier onto the tower creates more space and less heat inside the shelter. The RRH design delivers significant efficiencies across the board—reducing power, cooling and space requirements. As a result, it is quickly becoming the accepted architecture for many macro site installations.

Getting backup power to remote radio heads

Prior to the introduction of RRHs, all radio equipment was located in the base station shelter or cabinet where there was ready access to the backup batteries. All we had to worry about was bringing the RF signal from the radio up to the antennas. Easy enough—just use a coaxial cable. Moving the radio transmitter and amplifier to the top of the tower, however, meant we now had to get power up the tower as well. So long as the site is operating from the main power

system, we can power the RRHs by simply replacing the coaxial cable with a power conductor (Figure 10.14).

But what happens when the power feed goes down and the site switches to backup battery power? Ensuring a steady and sufficient voltage from the backup batteries poses a different challenge. Each RRH needs a battery backup to ensure operation in case of a power failure. Because of weather risks, locating the battery on the tower isn't feasible, so it must be housed in the shelter, far away from the RRH. Due to a phenomenon known as “voltage drop,” a heavier gauge power conductor is needed to sustain the RRH's required voltage. This adds significant weight onto the already-overloaded tower.

The alternative is to find a way to convert the battery power to a higher voltage on the ground, then convert it to the needed voltage (+24 V or –48 V) at the RRH itself. This is the operating concept behind CommScope's PowerShift® solution. For information regarding PowerShift, see page 155.

Remote radio head (RRH)

A feature of base station architecture that separates a cell site base station's RF and baseband functions by locating the radio on the tower, near the antenna, for improved energy efficiency.

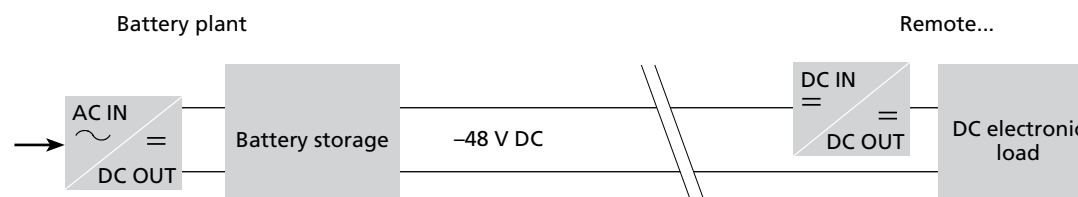

10.14: DC powering options for remote radio heads (RRHs)

Cell site power system configurations

Many cell sites house and maintain their power equipment in equipment shelters at the base of the cell tower. Inside these climate-controlled enclosures, equipment is mounted in equipment racks—with an integrated power system in one rack, battery strings in another, and radio equipment in a third.

Other sites place integrated compact equipment in outside plant (OSP) cabinets. This approach offers less space and fewer opportunities for environmental management, so only components specifically designed for OSP cabinet environments can be installed. Because of their size, often batteries will have a dedicated cabinet as well. A few examples of OSP cabinets are shown in Figures 10.15 and 10.16.



10.15: Integrated cell site battery-only cabinet



10.16: Integrated cell site power and battery cabinet

Powering tomorrow's wireless networks

As 4G/LTE wireless networks mature and rollout of 5G networks continues, powering the most cutting-edge technologies and architectures has emerged as a macro-scale strategic challenge. The following are some issues to consider.

Increasing power demands on the tower

As wireless networks evolve, their power demands continue to increase. Dual-band remote radio heads (RRHs), higher power carriers, and massive multiple-in, multiple-out (MIMO) antenna configurations are some examples of tower-top units that drive DC power consumption above 1 kilowatt—even approaching 2 kilowatts of demand.

How much copper is really needed? There is no single standard for determining the right size of conductors to use when connecting DC power to tower-top electronics; so, to make a good selection, one must consider several factors:

- **Voltage drop.** As current flows through conductors, there will be voltage drop due to the resistance of the cable itself. This means the tower-top electronics will always have a lower voltage than the power plant or the ground-mounted equipment. The tower-top equipment is constant power, so, the lower the input

voltage the higher the current needs to be to maintain the output power level. Voltage delivered to the tower-top equipment will depend on the power plant voltage, the size of conductors and the length of the conductors.

- **Design case.** The critical factor when sizing conductors to connect tower-top electronics is the power plant voltage when primary power is lost and the site switches to battery power. The battery starts at 48 V and will drain down (Figure 10.17) until the battery disconnect is triggered or the electronics reach their low-voltage drop-out value.

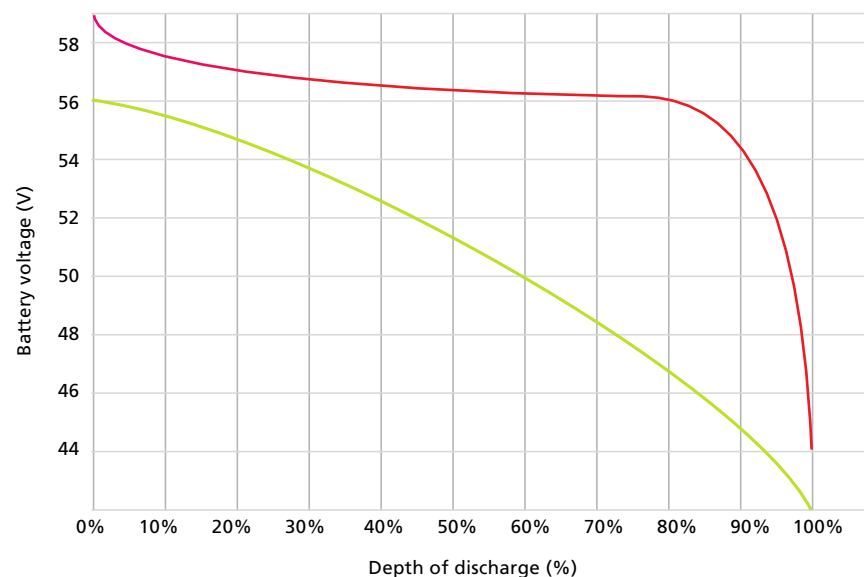

10.17: Integrated cell site battery-only cabinet

- **Battery backup time.** Depending on the reliability needed for a particular cell site, the tower-top electronics should have enough battery backup time for a technician to reach the site and ensure the generator has successfully started. This can typically range from two to eight hours.

The rule of thumb is to size the conductors for a 5 V drop when the cell site is on battery (48 V). When the battery powers the site, it will provide 48 V. So, the tower-top electronics will initially receive 43 V and will remain powered until the voltage reaches about 38 V (at which point the battery has drained down to 43 V). If the conductors are sized based on voltages supplied by the rectifiers while the primary power is connected, it is likely the tower-top electronics will either drop out when the battery is engaged or there will be little backup time. Here are some links to tools that will help properly size conductors.

- **Power line losses.** Energy efficiency really matters for cell sites—more so now than ever before. Power loss is a function of the cable's resistance multiplied by the square value of the current. Use 54 V to calculate the current for efficiency, since the rectifiers provide 54 V DC power to the RRUs when primary power is connected.

- **Electrical codes.** When the tower-top electronics operated at just 400 to 500 watts, the input currents were so low the conductor amperages for codes were typically not factors—voltage drop was the only criteria. As the power requirements increase, electrical codes such as the National Electrical Code have become a factor since the amperages in conductors can be exceeded for flexible cords.

In the U.S., reference the latest NEC table 400.5(A)(1) and 400.5(A)(3) if using SO type cables and Table 310.15(B)(16) and 310.15(B)(3)(A). Outside the U.S., reference the applicable standard for flexible cable ampacity.

- **Cost.** The initial cost of the cable and installation should be weighed against battery backup time, tower loading, permit costs, etc., in order to select the optimum conductor size.
- **Future proofing.** Consider the site evolution over the next few years so an upgrade is not needed soon after the cell site cabling is completed.

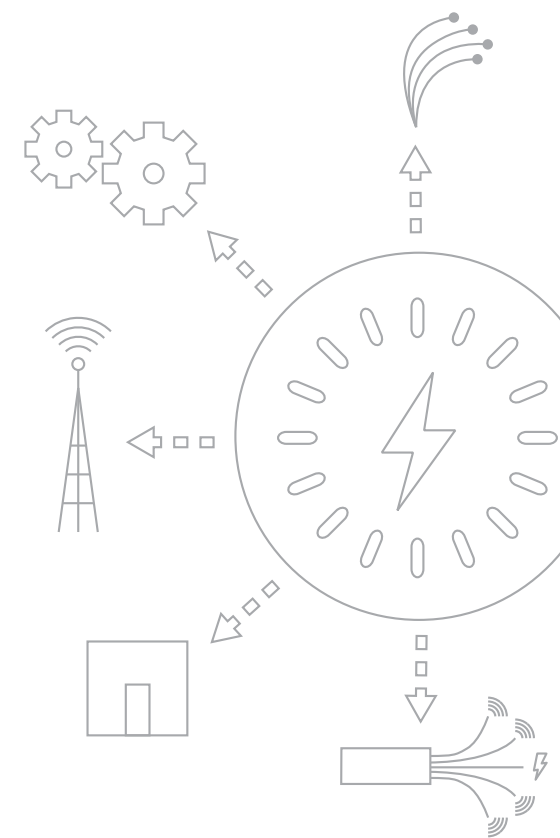

Macro solution

Developed by CommScope as a cost-effective solution for supporting higher-powered tower-top equipment, PowerShift® regulates voltage to the RRU by providing a higher DC voltage at the base (Figure 10.19). This reduces the current in the long conductors, which enables much more efficient transmission of DC power. PowerShift will also vastly improve battery backup time by maintaining the RRUs at their voltage setpoint—even as the battery drains down to as low as 36 V.

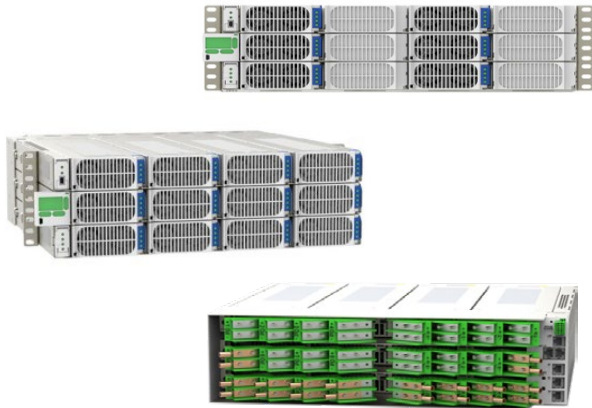

10.18: CommScope's PowerShift solution

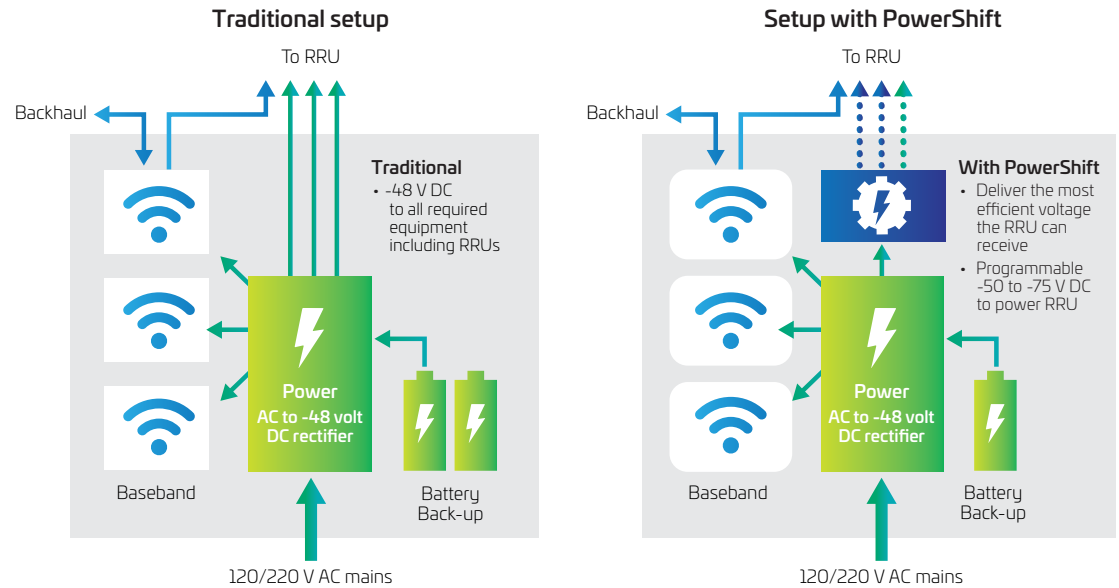

10.19: Set up with PowerShift

You can find more information in the [eBook Powering Wireless Networks](#).

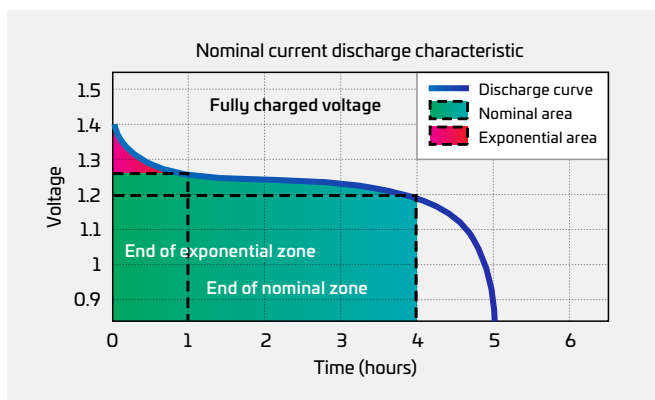

10.20: PowerShift in operation

PowerShift® is inserted between the battery plant and the trunk cable at the base of the tower. The battery output is fed into PowerShift, which adjusts its output voltage (VPS) to compensate for the cable voltage drop (VC), providing a regulated, programmable voltage to the RRU input (VL).

As the battery discharges down to 42 volts, PowerShift continues to boost its output to maintain the programmed input voltage to the RRU. This effectively eliminates the RRU dropout voltage as a major concern, ensuring full utilization of backup battery runtime by the RRU.

PowerShift also eliminates having to oversize the power plant and battery backup to handle a worst-case scenario. So, MNOs can save cost and accommodate higher-power RRUs in the future.

Wherever they are located, small cells require both data (fiber-optic cable) and power (copper) cabling to function. Hybrid cable, containing both fiber and copper, makes this possible. However, with the proliferation of new small cells, a new distributed power connectivity strategy is required to manage it all efficiently.

Powering small cell metro networks

Demand for wireless data is exploding, with 5G deployments increasing daily. To increase network capacity, wireless operators must increase the density of their networks—adding more antennas and radios to existing sites and deploying more sites where demand is greatest. This can mean adding thousands of small cells, up to 10 for every LTE macro site. And they all need power.

CommScope has developed a new approach, PowerShift Metro that uses hybrid that uses hybrid cabling to deliver power and connectivity from a central location to a cluster of neighboring small cells.

A suitable centralized location can be anywhere that has access to power and the optical network, such as an outdoor distribution cabinet, telecom closet or macro

Centralized radio access network (C-RAN)

A network architecture that moves baseband functions from individual sites to a remote location (a hub)—often with baseband units from multiple sites. Connected by high-speed fiber, C-RAN networks are extremely fast and efficient.

base station location. With DC-DC conversion rates now exceeding 95 percent efficiency, higher-voltage power distribution enables longer DC power runs that extend hundreds of meters. This greatly simplifies the amount of infrastructure work required to power small cells without involving the utility providers—a big advantage for wireless operators.

These deployments are most efficient for new clusters of small cells. During the planning stages of such projects is the best time to incorporate a centralized power source.

Learn more



To learn more about the CommScope PowerShift Metro solution, watch this brief video and see how PowerShift Metro can help you take control of your small cell networks.

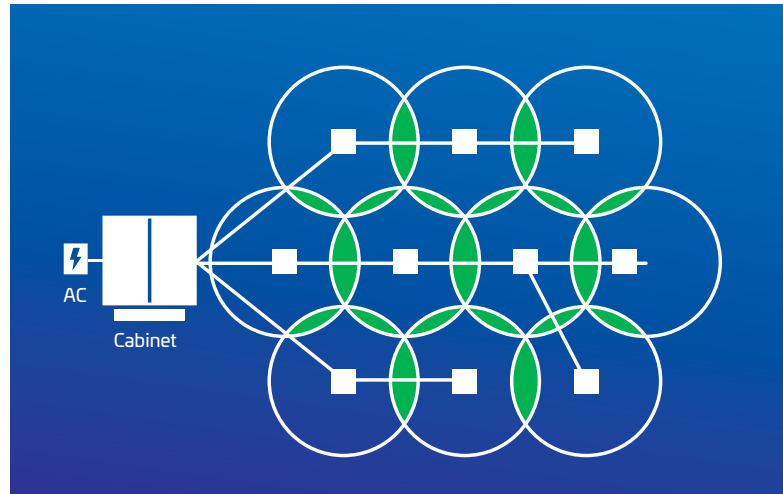

10.21: Controlled by the mobile operator, CommScope’s PowerShift Metro provides a separate power feed from a central location, eliminating the need for an onsite power rectifier and meter, and relieving equipment congestion at the small cell pole.

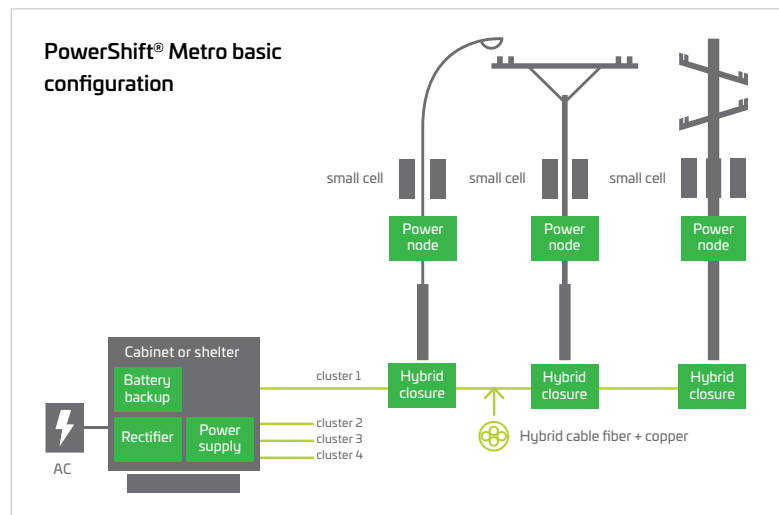

10.22: A cluster of small cells working off a central, higher-voltage power source

Chapter 10 summary

Powering macro sites

- DC and AC power
- Battery backups engage to bridge generator in the event of line power failure
- Modern networks draw more power and can benefit from intelligent DC power supply such as PowerShift

Powering metro sites

- Metro (small cell) sites are located on the edge of networks
- Central to continued 5G rollouts
- Unique power distribution needs, including intelligent DC power supply



Chapter 11

Successfully planning against failure:
Reliability in wireless systems

By now, assuming you've read some of the preceding chapters, you've picked up on more than a couple of very big and broad themes. Among those are the exponential growth of global cell data usage, the increasingly critical role that mobile networks play in our lives and livelihoods, and the new and pressing demands that emerging applications impose on mobile network infrastructure.

All three of these factors intersect at the broad issue known as "reliability."

From an engineering perspective, reliability is the probability that a component, product or system will perform as intended, under given conditions and for a stated length of time. Simple enough? Not be a long shot.

In this chapter, we'll unpack the challenge of the mobile network—understanding its component parts, how to measure it, and methods for improving it. By the end, hopefully you will realize just how complex (and, yes, beautiful) a reliably engineered network system is.

The timing couldn't be better. As demand for 5G services increases, 6G technologies are already making their way from the drawing board to the board room. The

continued drive for more bandwidth, faster throughput and lower latency performance is pushing the boundary of cellular performance. However, ensuring cellular reliability keeps up with accelerating network demands is difficult. In this chapter, we'll learn why—and what can be done.

Time is short and the topic is huge. Let's get to it.

Putting reliability in a broader context

Better network uptime, reduced maintenance cost, happier customers—these are all good reasons to work toward a more reliable mobile network infrastructure. But there's also something much bigger at stake: the fight to save our planet.

Every component, product and system failure carries a high environmental cost. Truck rolls consume fossil fuels and release CO₂. Parts that fail prematurely must be replaced, requiring more mined minerals, more production resources and more carbon impact during transportation.

It all adds up, making the challenge bigger than dollars and cents.

Reliability and reliability engineering in outdoor wireless networks

While it is impossible to eliminate all failures from a design, we can identify the most likely failures and the appropriate planning needed to mitigate their effects. That's the goal of reliability engineering. It involves systematically applying consolidated engineering

Reliability

The probability that an item will perform as intended, under given conditions and for a stated length of time.

principles and techniques throughout a product lifecycle—thus, reliability engineering.

Evaluating the reliability of a product or process can include a variety of tools used in reliability analyses and testing which help us understand a product or system’s reliability from different perspectives. The objective is to identify potential failures and work toward improving our processes. To achieve this, CommScope uses a strong multi- and inter-discipline reliability approach. It includes the various disciplines, procedures and tests used to study, measure and improve how well antennas and passive filters stand up to environmental factors such as wind loading and corrosion.

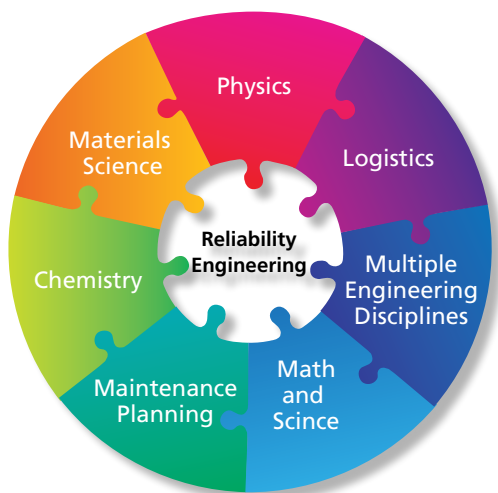

11.1: Integrated multi-/inter-disciplinary approach to reliability

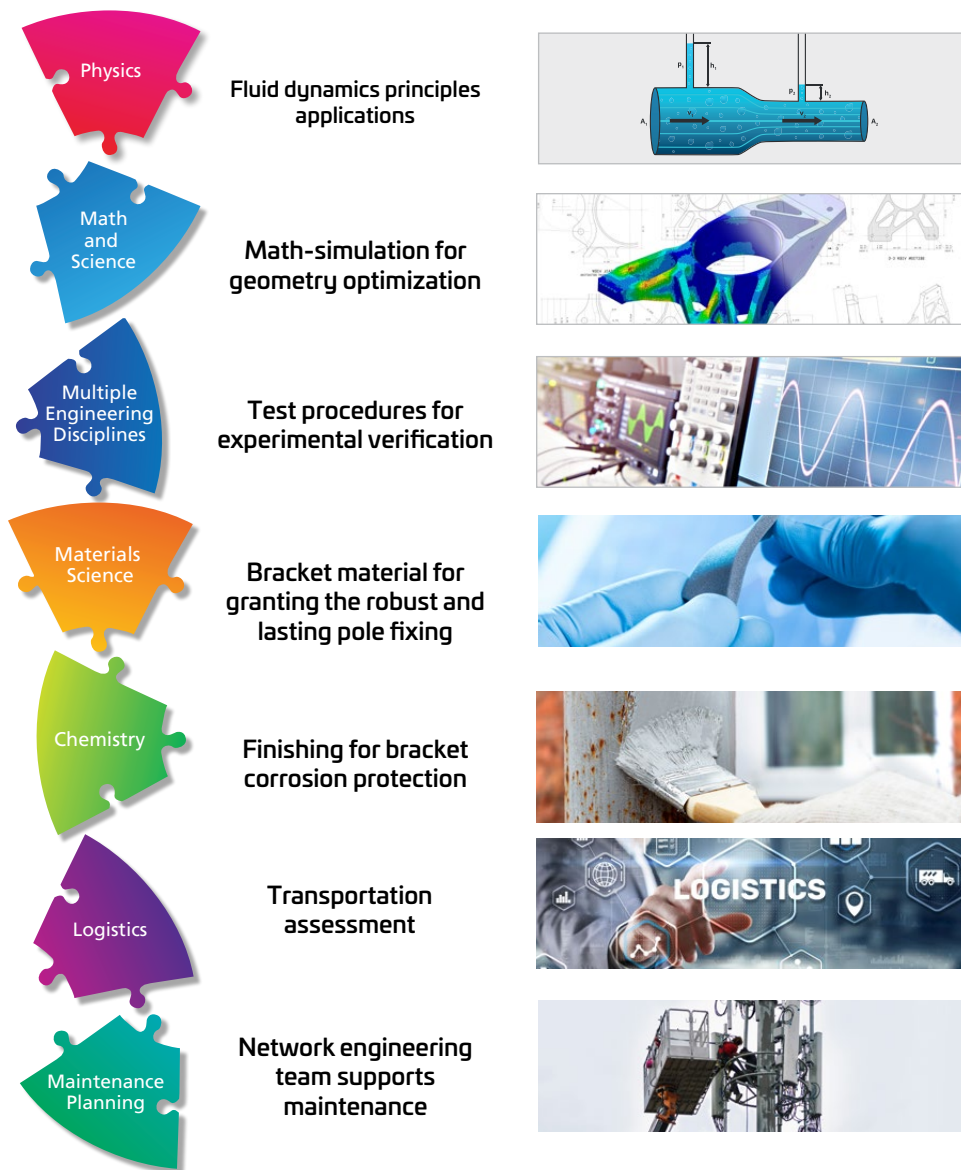

11.2: An illustration of the various disciplines, procedures and tests used to study, measure and improve how well antennas and passive filters stand up to environmental factors, such as wind-loading and corrosion.

Understanding failure rates across the product life cycle

As mentioned earlier, reliability is defined as the probability (P) that an item will perform its required function under given conditions for a stated length of time. The non-reliability probability (also known as “failure rate”) is usually depicted by the classic bathtub curve (Figure 11.3) which shows higher failure rates at the beginning and end of a device’s life cycle. For any given device, this graph provides a general guide as to its rate of failure—decreasing initially and increasing during end of life.

The bathtub curve can be divided into three phases of the product’s lifecycle:

- Early life failures are highly undesirable and are typically caused by defects and/or errors introduced during the design, manufacturing or assembly of the product.
- Steady-state constant failures are normally considered to be random cases due to the “intrinsic” characteristics of materials and components.
- End-of-life (wear-out) failures occur due to fatigue or depletion of materials, or components characteristics degradation.

The sum of the duration of these three periods must not be confused with the product’s useful life, which is limited by its shortest-lived component. Also, it is important to note that the bathtub curve does not depict the failure rate of a single item.

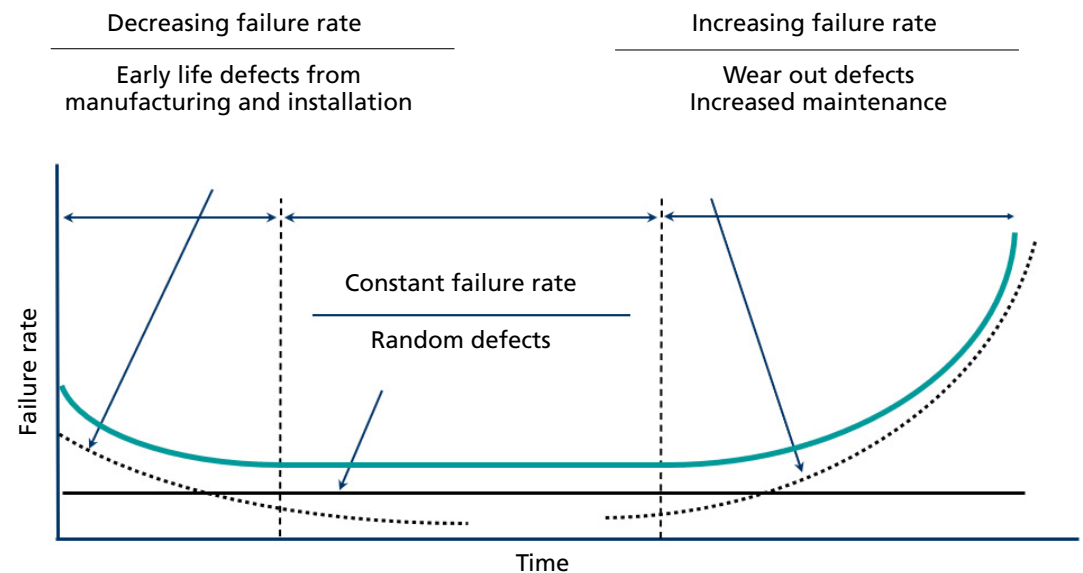

11.3: The reliability “bathtub curve”

Rather, it describes the relative failure rate of multiple products over time. Additionally, it is purely qualitative. This makes it nearly impossible to model product failure behavior using a calibrated bathtub curve.

Addressing the product life failure periods

Early life

Failures that occur early in a product's life are particularly damaging as they serve to undermine customer confidence and, if unresolved, enable an escalation of unreliability and further erosion of confidence. Moreover, they carry the highest environmental cost, as a failure early in the product's life forces the supply chain to re-produce and re-transport the replacement part earlier than anticipated. These failures are caused by defects designed (or built) into a product.

CommScope employs a standard design approach that includes a set of engineering reliability standard practices to prevent/minimize the early life failure. This includes failure mode and effects analysis (FMEA), design simulation, part stress calculation and accelerated life testing. FMEA is used during component, subsystem, system design, or process development to ensure that potential failure modes and their associated causes have been considered and addressed before releasing the

design. Design simulation and stress calculation enable designers to detect weak points in components and systems before the prototype is finalized. Accelerated life testing is used to generate potential failure and provide data that will help improve the product design.

Steady-state constant failures

This long, roughly flat portion of the bathtub curve is known as the "intrinsic failure period." During this stage of the product lifecycle, failures occur randomly and at a fairly constant rate. This is the stage we are most concerned with in this chapter. The worldwide used failure rate metrics in this period are the reliability predictions based on mean-time-between-failures (MTBF) calculations.

End of life (wear-out)

During this phase in the product lifecycle, components or materials degrade at an accelerated rate, increasing the failure rate. One of the important goals in design and manufacturing is to select appropriate materials, designs and processes and verify their reliability. To do this, CommScope utilizes a set of standard reliability engineering practices that include accelerated life testing and weathering/aging tests that measure the material's resistance to UV aging, corrosion aging, etc.

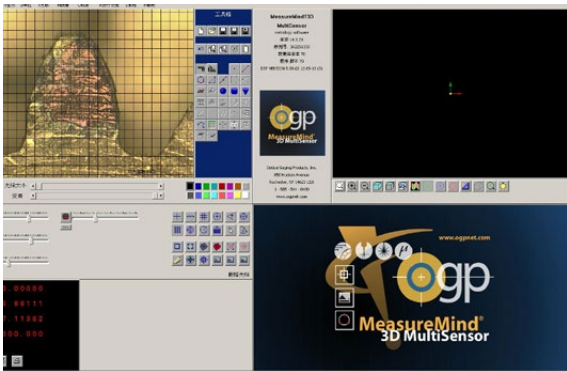

11.4: Gear materials analysis and selection



11.5: (Middle) and 11.6: (Right) UV aging test and continuous field exposure



Predicting reliability in a wireless network

System failure rate

Predicting the end-of-life stage for a wireless network is highly complex and requires understanding the end-of-life calculations for the main components, such as RET motors and cabinet fans. These components, in turn, consist of multiple sub-components whose moving parts are subject to mechanical wear and eventual failure.

Similarly, electronic components also have life expectancies. For example, electrolytic capacitors used in wireless electronics are subject to degradation from high temperatures and alternating current (ac) ripple currents.

Complex wireless systems such as base station antennas, tower-mounted amplifiers and CommScope's PowerShift® dynamic power supply solution are all composed of multiple components or "blocks." These blocks can

include active and passive electronics, RF components, mechanical and structural components, as well as non-structural parts.

The classical approach to calculating the failure rate for such systems consists of the following:

Reliability budget calculation

This calculation is obtained by dividing a system's functionality into subsystems and representing them using a reliability block diagram (RBD). The RBD (Figure 11.7) identifies functional blocks and redundancies and can be extremely useful in predicting system reliability. The shape of the RBD depends on the type of system architecture being considered. A typical architecture may include both redundant and non-redundant subsystems. Arrows represent the direction of

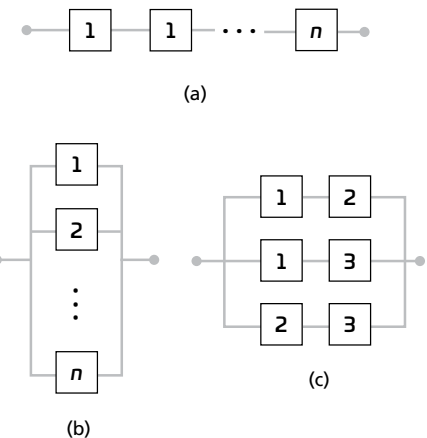

11.7: Reliability block diagram

information flow but may not necessarily correspond to the physical direction of current in the active system.

Predicting failure for each block in the RBD

Several methods can be used, either separately or jointly, to estimate the failure rate of each block:

- Collection of empirical field data
- Accelerated life testing data
- Prediction models based on “parts count” or “part stress” method
- System availability models for large systems with internal redundancy

Each method offers different advantages. The “parts count” method, for instance, is particularly useful for new product designs, even before the product moves beyond its design stages. This method applies established life-cycle information for the components used in the design—the steady-state failure rates indicated in Table 11.1 below—to create an aggregated model of potential failures.

Calculating system failure rates

Calculating system failure rates relies on reliability prediction tools such as Telcordia SR-332 Reliability Procedure for Electronic Equipment. This industry-standard software aggregates individual component failure rates and applies designer-specified multipliers to produce a final, steady-state failure rate for the component. The

multipliers account for specific temperature, electrical stress, production quality and environmental conditions.

Reliability prediction tools enable a designer to compute a predicted failure rate with 90 percent or greater confidence; at least nine out of 10 times, the actual failure rate will be no higher than predicted. These estimates usually reflect conservative numbers, making them highly reliable predictors.

Factors mentioned above are critical for the final reliability performance of a device in prediction, better control of the very factors will lead to a lower multiplier factors and lower system failure rate.

Stress factor (πSi): This is the ratio of applied voltage (or power) to rated voltage (or power) expressed as a percentage. Its value is a quantitative expression of the effect of stress on failure rate, as listed in Telcordia SR-332. Component derating design is quite important for a stable system. A 50 percent stress derating produces a stress factor of 1 for the component. Derating calculation and design are widely used in CommScope active devices.

Temperature factor (πTi): This refers to operating temperature and represents the sum of the ambient temperature and the temperature of the heat produced by the component itself. In practice, a 10°C increase in operating temperature can double the likely failure rate. Likewise, reducing the temperature by a similar amount

can reduce predicted failure rates by up to 50 percent. Temperature factor is 1.0 at a temperature of 40°C, which can be adjusted up and down from this reference point.

Quality factors (πQi): To predict failure rates, Telcordia SR-332 uses four quality levels for manufacturers. Each level is assigned a Quality Factor value, which is used as a multiplier of the basic failure rate. A better-quality level classifying will lead to a smaller multiplier quality factor to component. Failure rates are improved by manufacturer efforts to ensure the quality of their devices. Quality factor of outdoor wireless equipment is typically 1.0, which requires a solid system quality control of the device components. CommScope follows the TL 9000 quality management system through the entire product lifetime.

Environmental factor (πE): This factor accounts for variations in temperature, vibration and other environmental variables in an uncontrolled outdoor deployment versus the same equipment in a climate-controlled enclosure. It can have a significant influence on failure rates. For example, an outdoor environment introduces a multiplier of 1.2 to 2.0, depending on the outdoor application.

The final product of the reliability prediction tool includes detailed, part-by-part information such as shown in Table 11.1.

Failures in time: Computing system failure rates

“Failures in time” estimates the number of expected component failures per billion operating hours. The total system failure rate is the component failure rate plus the factor multipliers listed above. Failures in time can be derived using the following equation:

$$\lambda_{SS} = \pi_E \sum_{i=1}^N (\lambda_{Gi} \times \pi_{Si} \times \pi_{Ti} \times \pi_{Qi})$$

Where:

- πSi = Stress factor
- πTi = Temperature factor
- πQi = Quality factor
- πE = Environmental factor
- λGi = Generic steady-state failure rate for each component; values vary by component
- λSS = Steady-state failure rate for the total system
- N = Number of parts or subsystems used in the system

Failure rate calculation per Telcordia SR-332							
Assembly A (example)	N	λGi (FITs)	πSi	πQi	πTi	πE	λSS
PCB part—1	8	0.2	1.0	1.0	1.0	1.2	1.9
PCB part—2	8	0.2	1.0	1.0	1.0	1.2	1.9
Metal part—3	8	0.5	1.0	1.0	1.0	1.2	4.8
Mechanical part—4	8	0.5	1.0	1.0	1.0	1.2	4.8
Mechanical part—5	8	0.2	1.0	1.0	1.0	1.2	1.9
Mechanical part—6	48	0.5	1.0	1.0	1.0	1.2	28.8
Mechanical part—7	4	1.0	1.0	1.0	1.0	1.2	4.8
Subtotal	/	/	/	/	/	/	48.9

Table 11.1: Example of part counting method

Measuring reliability

As mentioned above, reliability is the probability that a device will perform correctly under defined operational conditions over a specific span of time. But supporting this general definition are several practical ways of measuring reliability in real-world applications.

Mean time between failures

Mean time between failures (MTBF) is the time between two consecutive failures. This is the most common definition for reliability. MTBF is expressed as the inverse of the failure-in-time rate.

It can be calculated using the equation:

$$\text{MTBF} = 1 / \text{Failure rate} = 10^9 / \text{FITs}$$

Note: While MTBF is the time between failures and can be expressed in hours, months, cycles, etc., it does not represent a duration, but a probability of failure.

Mean time to repair

Mean time to repair (MTTR), sometimes called “mean time to restore,” is the time needed to repair or replace a failed component and restore its function. This includes procurement and travel time, so the figure is comprehensive in its scope.

Availability

Availability (A) is the percentage of time the system as a whole operates normally. When someone refers to “four nines of reliability,” they mean “99.99 percent uptime” (Table 11.2). Availability is a function not only of how often a component fails, but also how long it takes to restore service when it does fail. Therefore, it is a function of both MTBF and MTTR.

Availability is calculated using the equation:

$$A = \text{MTBF} / [\text{MTBF} + \text{MTTR}]$$

When describing the reliability of an entire system, availability is a more useful measurement. That’s because redundancies built into the design may tolerate some individual failures without seriously compromising the function of the system as a whole.

Unavailability

Unavailability (U) is the flipside of availability; it expresses the percentage of time a system is not working properly. Like availability, it can be calculated as a function of MTBF and MTTR: $U = \text{MTTR} / [\text{MTBF} + \text{MTTR}]$. As you may expect, $A + U$ always equals 100 percent.

Downtime

Downtime (DT) is derived from unavailability and is expressed as the average amount of time per year the system will be in an unavailable state. Since it measures failures that often last only minutes—and expresses them as a percentage of a full year—we simply multiply the unavailability percentage by the number of minutes in a year, or 525,600.

$$DT = U \times 525,600$$

Consider a system with 99.99 percent availability, “four nines.” Its mathematical value is .9999, resulting in a U value of .0001. Multiplying .0001 by 525,600 yields an expected annual downtime of 52.5 minutes per year, or less than a full hour. This is a key indicator in overall service quality (Table 11.2).

Budgeting for failure

Dividing a system’s functionality into subsystems enables us to calculate a “reliability budget.” By breaking down the complex whole into manageable segments, subsystem reliability can be more easily modeled based on its parts count or by another appropriate method. Then the likelihood of failure of the entire subsystem can be modeled to learn its effect on the overall function of the system.

In a practical example, consider the number of active (electronic) components mounted atop a cell site tower. The system can be broken down into subsystems involved in the transmit path, receive path, power system and other related functions. Each subsystem is assigned a maximum allowable failure rate based on its importance to the operation of the system. To enable the site’s designers to plan accordingly, the overall reliability budget is split up and allocated where it is needed most.

Accounting for ESG impacts

MNOs must also understand how their “failure budget” will impact corporate environmental, social, and governance (ESG) measurements and goals.

Percent availability	Number of nines	Downtime (minutes/year)	Service quality level
99%	2-Nines	5,000 m/y	Moderate
99.9%	3-Nines	500 m/y	Well managed
99.99%	4-Nines	50 m/y	High availability
99.999%	5-Nines	5 m/y	Very high availability

Table 11.2: Service quality measured by uptime; more nines means more availability

In practical applications, these models are more concerned with the functioning state of a system or subsystem, rather than with the actual hardware or software itself. At this level of planning, MTBF and MTTR become more meaningful descriptors of reliability than failure rate alone.

Failure mode and effects analysis (FMEA)

Given enough time, component failure is a certainty. Where and when it occurs, however, is a variable that must be modeled to be predicted. That involves running multiple what-if scenarios that not only evaluate potential component failure but the effect of that failure on its subsystem and the effect of that subsystem on the system as a whole. Failure mode and effects analysis (FMEA) is a simple, table-based method of measuring these variables together. The FMEA for a particular system lists each failure mode and its effect on overall system performance. Failures that result in total loss of service are combined to calculate the system's total availability, while failures that cause only minor effects on service are combined to calculate the system's partial availability.

Fault-tolerant design (redundancy design)

Redundancy is the key to boosting system availability without requiring the subsystems to be more reliable. Redundancy schemes vary by application, but they all

have one thing in common: on-demand access to a device or service that can assume the function of a failed device until it can be repaired or replaced. Sometimes this includes a spare component; other times, it means shifting load to other systems. Common redundancy schemes include:

- **Active/hot standby:** A spare component built into the system operates all the time and can assume more load when needed due to primary component failure.
- **Active/cold standby:** A spare component built into the system but which comes online only in the event of failure, with a possible interruption in service.
- **1+1 load sharing:** Two active communication routes are provided to ensure one will be available in the event that component failure causes an outage in the other.
- **N+1 load sharing:** A standby alternate route for communications is established to assume the load in the event that component failure causes an outage in any of the other routes.

Revisiting the reliability block diagram

Another widely used approach to measuring system reliability is the reliability block diagram (RBD). Unlike the list-based FMEA table, the RBD graphically shows the interconnections between subsystems and how redundancy measures are integrated. Also, these element

“blocks” are described purely by function, not by individual component; the system’s reliability depends on how these blocks are connected.

An RBD is extremely useful in predicting system reliability, but it does have disadvantages. The main limitation is its static nature; it can only predict individual failures without accounting for cascading effects throughout the system as it continues to operate in a degraded state.

State transition diagram (Markov Model)

In non-redundant systems, there are two states of being: working and not working. Transitions between these two states are defined by failure rates (1/MTBF) and repair rates (1/MTTR). Between these two measurements, availability can be easily determined.

However, more complex fault-tolerant systems have multiple levels of operational efficiency, including degraded states and states of partial failure. To measure the reliability of these complex systems, the Markov Model defines all possible operational states of the system and maps every transition between operational states.

To illustrate, consider a simple system with two subsystems, A1 and A2, each with the same failure rate (Figure 11.8).

There are three possible operating states: fully operational, partially degraded, and completely unavailable. The arrows indicate potential failure and repair transitions

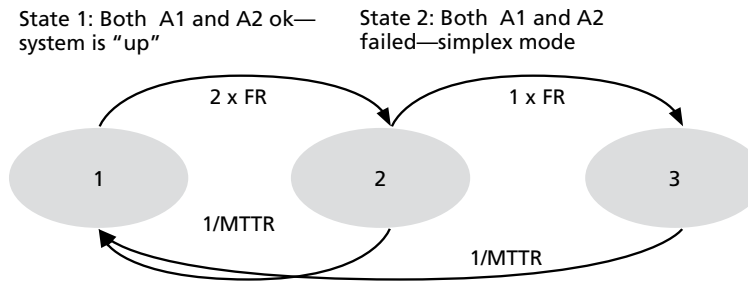

11.8: Markov Model describing the three possible states for a two-subsystem design

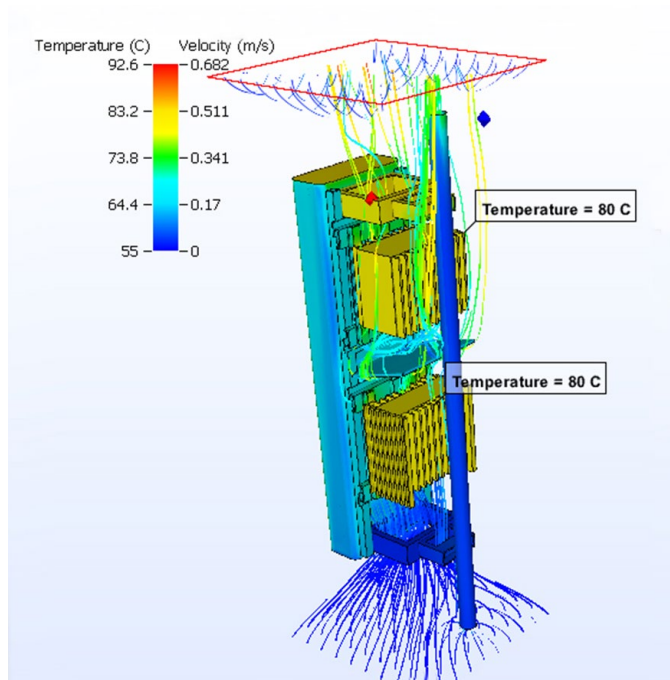

11.9: Thermal simulation and tolerance analysis

between states, with the failure and repair rates for each. Different failure rates among subsystems naturally introduce additional variables, but the computations remain the same.

Markov Models can account for multiple combinations of failure conditions and the effect each has on system performance. This offers a better view of the comparative severity of different subsystem failures and what kinds of degraded performance can be expected.

Markov Models are very useful in calculating the cost/benefit analysis of steps designed to reduce failure rates at various places within a system—essentially putting a “time and trouble” cost on any possible subsystem failure. This is particularly valuable when considering how difficult it is to service outdoor wireless network equipment. It can also inform design decisions at the planning stage, taking into account accessibility factors early in the process. The downside to the Markov Model is that it cannot assign a single MTBF value or failure rate to the entire system.

Improving reliability

Now that we are able to gauge system reliability, the question becomes: What can be done to improve that reliability? Better reliability begins in the design phase and must be reinforced at every stage, from production to installation and maintenance.

Two important aspects to note are the roles played by environmental issues and transportation/installation when dealing with active/passive products designed for outdoor wireless applications. Environmental variables like temperature variations, moisture, lightning strikes and other local conditions all play a part in how reliability is measured and improved. So, too, how products are packaged, transported and installed can significantly impact reliability. Each consideration should be thoroughly qualification tested and any applicable industry standards taken into account.

Thermal design considerations

Along with the generation upgrading of wireless systems, more compact design/higher power/integration of active and passive parts are the tendency of the wireless system which is a challenge on reliability, where need to consider:

- Robust margins for thermal tolerance (Figures 11.9 and 11.10)
- Design to conform to outdoor specifications
- Integrated thermal protection against over-thermal conditions

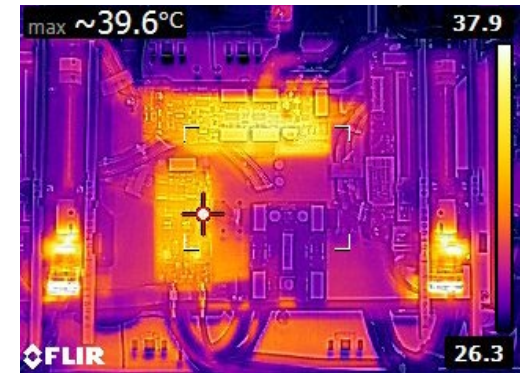

11.10: FLIR PCBA thermal imaging

Mechanical considerations

- Resistance to high winds and vibrations on rigid mounting (Figure 11.11)
- Accommodation of expansion and contraction
- Mechanical change-induced drift compensation

Atmospheric considerations

- Resistance to water infiltration
- Resistance to corrosion, fading and peeling
- Connectors, seals and gasket design (Figure 11.12)
- Proper lightning mitigation (shielding and grounding)

Packing/transportation

Proper packing design and transportation is required to protect the product itself. The ISTA standard is commonly used to simulate and validate the transportation. Additionally, transportation data tracking and collection can help determine a safe and proper severity level.

Installation

It's vitally important to work with a competent and experienced cell site services company with well-documented safety records and tower climb-certified technicians to handle both mechanical and electrical services. Qualified technicians will reduce the chances of improper lightning protection, poor connections, mishandled feeder cable, and weatherproofing problems.

In the long run, maintenance and troubleshooting—when performed by trained professionals (Figure 11.13)—are much easier and less disruptive to your network.

Reliability testing

Many reliability tests are designed to improve product reliability from early design prototype to deployment. These include engineering verification testing (EVT) and design validation testing (DVT), which take place during product development. The purpose is to detect potential failures related to the designs, materials or processes during the design phase. This testing provides a thorough understanding of the product's weak points—enabling product reliability performance to continue improving.

Ongoing reliability testing (ORT) monitors reliability performance as the product moves into mass production. At CommScope, ORT involves RF/electrical monitoring, environmental testing, transportation testing, safety and regulatory testing, and customized special testing to improve product reliability from early design prototype to deployment. Most of these tests are standards-based, adhering to protocols and procedures outlined in standards such as IEC, EN, ETSI, and ISTA. Additional standards can also be applied as requested by the customer. An RF return loss test is shown in Figure 11.14 on the next page.



11.11: Wind tunnel testing of a base station antenna



11.12: SureGuard weather proofing design in HELIAX product



11.13: CommScope network engineering team in the field

Robustness and life testing

Accelerated life testing (ALT) evaluates the long-term reliability of a product. A sample of units is subjected to more severe thermal conditions than would normally be experienced in the field. A typical ALT includes high temperature dwells (excursions) and more frequent thermal cycling to stress the unit's electrical components and mechanical attachments. Testing duration varies by product but typically last 60–100 days. A salt fog corrosion aging test is shown in Figure 11.15.

Highly accelerated life testing (HALT) is designed to expose latent defects in design components and manufacturing that would not otherwise be found by conventional test methods. HALT stresses the products to failure in order to assess design robustness and marginality. HALT regimes may be tailored to the product architecture and complexity and can include:

- Step temperature stress
- Voltage stress
- Thermal dwell stress
- Rapid thermal cycling stress
- Random vibration stress
- Combined thermal cycling-vibration stress
- Other stress tests that may be product applicable

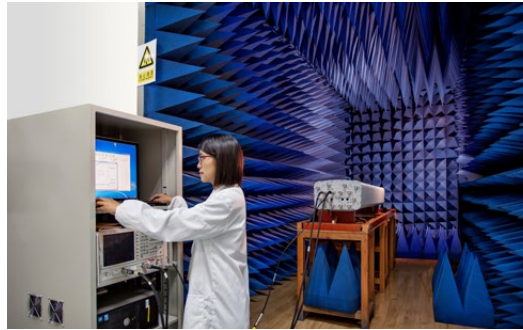

11.14: (Left) Return loss test



11.15: (Right) Salt fog corrosion aging test

Recent developments in reliability

Thermal design

CommScope is always working to develop more thermally efficient designs. This includes exploring methods for making more effective heat sinks for transferring heat from components to the air. We are also a leader in the field of materials science—developing and experimenting with alternative materials that can continue functioning as needed in extreme conditions. Currently, our use of thermal simulation tools and reliability experimentation is considered an industry best practice. It combines theory and real-world situational analysis that help inform more innovative thermal product planning and design.

Field data analysis

CommScope continuously monitors field returns and performs root-cause analyses on those returns. These analyses inform our design and manufacturing processes so we can prevent potential problems at the source rather

than on the tower. Positive field results show continuous improvement over time—proving that the process works. We’re building a whole new layer of reliability into each product.

Ensuring a reliable network

In outdoor wireless communications, every design choice involves a tradeoff. In exchange for more efficient use of power and space in site deployments, there exists a greater risk of component failure. Such failures are a part of life, but they have also to be part of the plan.

Predicting and measuring reliability can be a complex process with many competing aspects. Determining the reliability of a component, a subsystem or an entire site depends heavily on what matters most: maintenance time and costs, fault tolerance performance and a host of other considerations.

In modern communications, there are no one-size-fits-all solutions. Every step to improve reliability represents a careful balancing act between performance expectations, installation, maintenance budgets and risk tolerance. CommScope helps make those decisions easier with the technology and insight that let you choose the right solution from the best available options.

Chapter 11 summary

Reliability in wireless systems

- Reliability engineering is multi- and inter-disciplinary integrated approach
- Reliability over life span is defined by the bathtub curve
- Life period stage in bathtub curve

Reliability factors

- Stress factors
- Temperature extremes
- Environmental factor
- Quality factor

Measurements of reliability

- Failure rate
- MTBF
- MTTR
- Availability
- Unavailability
- Downtime

Reliability prediction tools

- FMEA
- RBD
- Markov Model

Testing regimens

- Engineering verification (EVT)
- Design validation testing (DVT)
- Environmental testing
- Transportation testing
- Safety and regulatory testing
- Accelerated life testing (ALT)
- Highly accelerated life testing (HALT)

Reliability improvement opportunities

- Product simplification
- Better thermal design
- Better mechanical design
- Proper packing/transportation
- Installation best practices



Chapter 12

Simplifying RF deployment where it matters

As demand for 5G coverage and capacity rises, spectrum availability—or rather, lack of it—continues to be a bottleneck for wireless growth. In response, governments around the world continue to open up additional spectrum, especially in the higher frequencies. As the new spectrum becomes available, mobile network operators (MNOs) waste little time building out their networks in order to utilize it. In many cases, the RF equipment needed to support the new frequencies is simply added to already-crowded macro cell towers. This approach is quickly becoming unsustainable. Network planners need other options. Below are a few options to help simplify and build for the future.

Adding small cells to the mix

As discussed in previous chapters, high-frequency signals are great for increasing capacity but are limited in terms of how far they efficiently propagate and what kind of obstacles they can work around. One popular solution for simplifying RF deployment is to deploy large numbers of small cells that work together to exploit the advantages of high-frequency spectrum without relying on large sectors.

True to their name, small cells are downsized versions of macro cell sites. All the required RF equipment—base station, radio and antennas—are typically combined in a single self-contained unit. Each small cell creates a discrete “cell” of coverage. Like macro cell sites, however, traditional small cells also create areas of overlap where their cell boundaries meet. This problem can be mitigated through thoughtful design and careful optimization of small cell placement and power optimization.

Typically, small cells operate in spectrum above 1700 MHz and cover limited and well-defined areas. Because small cell deployment scenarios can be wildly varied, selecting the right small cell solution for the individual location requires careful consideration of the performance levels and capabilities available.

Another constant concern for small cell deployments is that of appearance. Zoning regulations vary from place to place, and balancing high performance with small size can be difficult. CommScope offers a wide variety of concealment options for a fully integrated small cell architecture that includes power supplies and antennas.

Metro Cell solutions

CommScope's broad portfolio of Metro Cell solutions (Figure 12.1) addresses the specific zoning and performance challenges that often delay or compromise small cell deployment schedules. The diverse portfolio enables operators to grow their 5G networks and leverage more efficient infrastructure designs, and municipalities can provide connectivity to both mobile users and smart devices without compromising aesthetics in public spaces.

Thus, Metro Cell solutions help MNO providers address their most pressing network challenges:

- **Densification:** Easily add network capacity in high-traffic environments
- **Aesthetics:** Compact and camouflaged, they satisfy municipal requirements
- **Flexibility:** Supports a mix of 4G and 5G mmWave capabilities
- **Coverage:** Fills the coverage gaps that macro sites can't

Metro Cell options include pole top, mid-pole, and integrated pole products. Customizable options include multiple colors and heights, decorative bases, poles, lighting and more. All solutions offer full integration with new or existing 4G/5G networks as well as smart



12.1: Metro Cell solutions portfolio

city devices such as traffic cameras and other equipment. These solutions can be paired with a range of supporting technologies, such as PowerShift® Metro (centralized power delivery and monitoring), battery backup and fiber backhaul for multiple small cell node clusters. When deployed together, they create a robust, compact and reliable small cell site.

A smarter, easier way to power small cell networks

As mentioned in chapter 10, PowerShift Metro is an innovative solution that delivers cost-effective power, fiber and battery backup to clusters of small cells up to two miles away.

The heart of the PowerShift Metro solution (Figure 12.2) is the power hub—alternating current (ac) power supply, rectifier and battery backup—that can be deployed from any central location or macro site. The power hub

distributes power (from the grid) and up to 144 fiber strands to clusters of small cells arranged in a “hub and spoke” architecture. The power hub also contains enough battery backup to deliver full power to the small cells should the grid power fail. The power hub is a fully self-contained power station complete with cooling, power and space for additional gear, so operators can use it to install and house other components such as virtualized distributed units, baseband units, compute and network switches, and more.

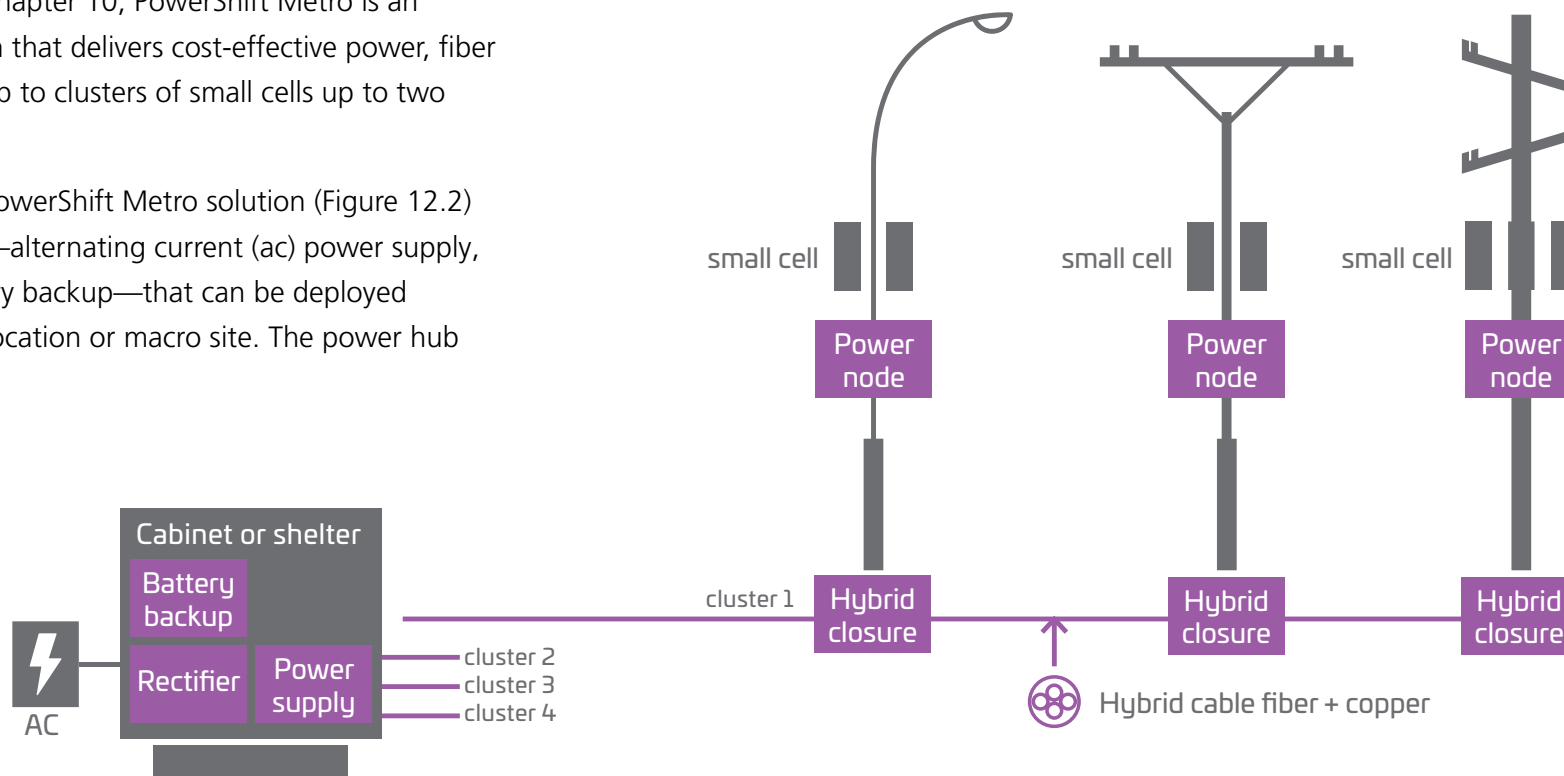

12.2: PowerShift Metro | Source: CommScope

Benefits

By eliminating the excessive time and costs required for a utility drop, MNOs can deploy power to their small cells faster and less expensively in places where power is not quickly and easily available. It also allows for battery backups or generators at the centralized location to support busy or mission-critical small cells.

By reducing the number of uncontrolled variables—scheduling delays, electrician availability, additional meters—the distributed power connectivity solution gives operators full control over how, when and where to add small cell coverage. This enables MNOs to swiftly respond to new market opportunities and increase speed to revenue—capabilities that are critical in an increasingly competitive marketplace.

The variable-voltage power supply also reduces OpEx by enabling peak shaving across small cell sites. When the demand and cost for grid power are highest, MNOs can avoid spikes in power consumption by leveling out peak use of electricity. This not only reduces the amount of energy purchased, but it also improves power grid stability.

Key Benefits:



Reduce operating costs and dramatically lower installation costs



Accelerate time to market



Ensure service continuity



Prepare your power infrastructure for the future



Reduce congestion on the pole

Passive active antennas

There is also a need to simplify installation on macro cells. As 5G deployments add more antennas and radios on the tower, finding space to mount stand-alone single-band M-MIMO (massive multiple input, multiple output) AAS (active antenna systems) becomes more difficult. One solution is a passive active antenna (Figure 12.3). This is a passive antenna that combines active components to support 4T4R or 8T8R radios. These antennas are designed to accept an AAS on the back of the structure, providing passive and active functionalities (on certain frequencies) on a single pipe position. The key enabling feature of this design is a window on the passive structure that allows the AAS frequencies to pass through, despite the presence of radiating elements on the passive structure that are in the direct path of the AAS radiating array. This minimizes the frontal area needed to deploy all the radiating apertures. In addition to reducing the number of required pipes per sector face, the design also reduces wind load.



12.3: Passive active antenna | Source: CommScope

Chapter 12 summary

As operators continue rollout of their advanced 5G services, the RF path is growing more complex—making it harder to deploy, manage and upgrade. Simplifying the complexity at the cell site and across the network is critical. Fortunately, there are some relatively easy ways to do this:

- Adding small cells to the mix enables expanded coverage and capacity.
- Tougher zoning requirements and local aesthetics threaten small cell deployment schedules.
- Solutions like Metro Cell help meet zoning requirements while maintaining excellent RF performance.
- PowerShift provides an easy and efficient option for ensuring reliable power to small cell clusters.
- Passive/active antenna technology further simplifies the macro layer by enabling active and passive arrays to coexist in the same basic footprint without affecting signal quality.

Author biographies



Mike Wolfe—CTO, Outdoor Wireless Networks

Mike is an evangelist for CommScope outdoor wireless solutions, overseeing strategy, marketing and technical support within the Outdoor Wireless Networks business segment. He has over 30 years

of experience in wireless technology, and his passion lies in making CommScope the most valued partner to our customers as they continuously evolve their networks towards 5G technology and beyond. Prior to his current CTO role, Mike held a variety of roles in system engineering, product management, and sales at CommScope, and he also worked for 14 years in the defense industry.

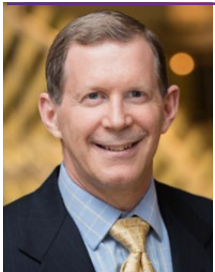

Marty Zimmerman—CTO North America, Outdoor Wireless Networks

Marty Zimmerman is an engineering fellow with CommScope. His current role is CTO for North America for the Outdoor Wireless Networks (OWN) business

segment. His primary role is working with customers and BU resources to identify problems needing solutions for improving the performance of 4G and 5G mobile wireless networks. Other duties include managing the BSA IP portfolio and leading the OWN Technical Support team. Previously he served as the global lead for technical business development for BSA and also served as the head of Technical Sales Support for North America. Prior to that he served as director of Engineering for BSA after working his way up from being an antenna design engineer. Prior to that, he worked as an antenna engineer for Sinclair Technologies and Analex, a NASA contractor. Marty holds 80+ U.S. patents and

numerous foreign patents in addition to having been published in several journals. He has a bachelor of science degree in electrical engineering from the California Institute of Technology and a master's degree and Ph.D. in electrical engineering from the University of Illinois, Urbana-Champaign.



Pedro Torres Martos—CTO Europe, Outdoor Wireless Networks

Pedro Torres Martos is CTO Europe for Outdoor Wireless Networks at CommScope. Pedro has more than 20 years of experience in mobile

networks in different roles. He started his career in R&D at Ericsson Sweden, worked as RAN and IP network expert and led the introduction of LTE and Heterogeneous Networks in the Mediterranean region. After two years as RAN CTO for Telefonica Global he moved to CommScope in 2015. Pedro holds a master of science degree in telecommunications engineering and an executive MBA by UNC Kenan-Flager Business School. He is also a member of the 5TONIC steering board.



Carla Annovazzi—Principal Reliability Engineer

Carla began her career as an electronic designer at Thales Alenia Aerospace (formerly Laben). As part of the On Board Data Handling group, she conducted reliability analyses on circuit

designs for scientific satellites. Carla joined CommScope in 1996 as product quality manager, developing quality and reliability programs and interfacing with customers as needed. In 2000, she assumed the role of reliability manager, where she managed CommScope's internal laboratory and was a key contact with

outside facilities personnel. Carla now serves as principal reliability engineer for the Outdoor Wireless Network group, specializing in RF filters and combiners. Carla holds a master's degree in physical science from the University of Milan, Italy.



Marcus Ash—Product Manager

Marcus Ash is a product manager at CommScope with over 34 years of experience in wireless telecommunications infrastructure products, including fiber-to-the-antenna, active products, coaxial cables, and

connectors. He previously worked in Field Engineering Services, providing on-site support for the installation of all RF products.



Xu Bin—Lab Manager

Xu joined the CommScope Outdoor Wireless Network group (Suzhou, China) in 2014 after working for CRRC as a material development engineer. In his initial role at CommScope, Xu worked as reliability engineer on the base station

antenna portfolio. In 2020 he was promoted to lab manager, working on reliability initiatives for CommScope's HELIAX® coaxial and fiber products. Three years later, Xu's role expanded to include product reliability for the power systems in CommScope's Outdoor Wireless Network group. He also has expertise in product reliability engineering and failure analysis for filters, connectors and cabling. Xu holds a master's degree in material science from Nanjing University of Science and Technology.



Thomas Craft Jr.—Director of Engineering

Tom is an engineering director for the RF and Power business unit within the Outdoor Wireless Networks segment of CommScope and is responsible for technical strategy and innovation

development. He has spent his career creating innovative solutions for next-generation information and communication technologies. He was a member of technical staff at AT&T/Lucent Technologies Bell Laboratories developing products for light wave, military submarine and ship-based electronics, and digital loop carrier systems. Since joining CommScope in 2007, he has worked to develop emerging technologies for telecommunications in the areas of fuel cell backup power systems and low rack count prefabricated modular data centers for high-performance computer environments.

Currently, Tom is working to develop power systems to enable the implementation of reliable and converged 4G and 5G networks. He holds more than 18 U.S. patents and has a master's degree in mechanical engineering from the New Jersey Institute of Technology. He is based in Richardson, Texas.



Brian Eichenser—Director of Operations

Brian is a director in the Comsearch business unit, responsible for several areas, including the commercial and technical support of the iQ.link microwave link design software product,

the direction of the Comsearch customer service group and GIS group and the management of Comsearch's customer-facing website and content.

With over 30 years of experience and a degree in electrical engineering, he has been involved in most every aspect of microwave spectrum management, including detailed line of sight analysis, availability and performance calculations, interference analysis and coordination with microwave and mobile licensees, software requirements, Q/A, and migration of legacy software to the cloud.



Mark Gibson—Sr. Director, Business Development and Regulatory Policy

With 40 years of wireless experience, Mark is responsible for developing domestic and international business opportunities for CommScope in the

areas of RF engineering and spectrum management. In addition to leading technical and business development efforts for numerous wireless and spectrum-related products and services, he has led efforts to address spectrum sharing between federal government and commercial users. He leads CommScope's efforts to develop, test and certify the Automated Frequency Coordination system for 6 GHz unlicensed bands.

He is a board member regulatory officer of the OnGo Alliance and president and chair of the Wireless Innovation Forum. He is a member of the Commerce Spectrum Management Advisory Committee, where he has also co-chaired working groups related to spectrum sharing and data exchange issues and has testified before the U.S. Congress on spectrum policy and related matters. He has led spectrum management efforts, including spectrum sharing analysis protocols and sharing criteria, as well as development of engineering services and software products. He speaks frequently and has authored several papers on spectrum sharing and relocation and has advised numerous wireless participants in their system design. He has a BSEE from the University of Maryland and is a life member of IEEE.



Jared Haines—Director of Product Line Management

Jared Haines is currently the director of Product Line Management at CommScope for the Structures and Small Cell business units. Jared has over 20 years of experience in the telecom industry. He started his career as an entry-level tower

technician while also being a full-time student at SUNY Oswego where he completed his undergraduate degree. Over the years he has held more senior roles on the business side to help develop solutions for CommScope both in the United States and abroad. Today, as a director of Product Line Management, he leads the teams for Structures and Metro Cell (small cell) business, applying his experience from his early years in the field to the product portfolio throughout the product lifecycle.

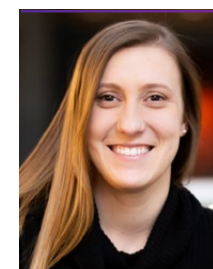

Sam Merta—Manager of Business Development

Samantha joined CommScope in 2018 as a mechanical engineer in the Outdoor Wireless Network (OWN) group, specializing in base station antenna (BSA) concept design, simulation and analysis.

In 2023, she moved into her current role as manager of business development, coordinating new product and technology design work between product-level management teams and research-and-development personnel. Among the outdoor wireless solutions Samantha has helped bring to market is CommScope's MOSAIC, a future-ready active and passive antenna solution.



Matt Morris—Sr. Director of Product Line Management

Matt Morris is currently the senior director of Product Line Management at CommScope, covering RF and Power solutions for the NAR and CALA regions. Matt has over 12 years of experience in

the telecom industry, starting his career with Verizon Wireless and joining CommScope in 2018. Since joining the CommScope team, Matt has worked as part of Sales, former Mobile Network Engineering, and now Product Line Management within the Outdoor Wireless Networks (OWN) segment. As part of RF and Power within OWN, Matt's team is responsible for power solutions globally, as well as base station antennas, filters and cabinet solutions for NAR and CALA.



Weidong (Lambo) Wen—Director of Quality and Reliability

Lambo began with CommScope in 2006 as a reliability engineer at Andrew Solutions (Suzhou, Jiangsu, China) where he specialized in the testing, failure analysis and reliability prediction for

base station antennas (BSAs). In 2015, he was appointed manager of the Reliability Center in Suzhou, China. Within four years, Lambo was named director of quality and reliability for all BSA solutions in China, including antennas, cabinets, RF power solutions, filters, HELIAX® cables and electromagnetic compatibility. Lambo helped initiate adoption of the Base Station Antenna Testing Measurement Standard in China and has published multiple papers on BSA antenna reliability prediction and field polymer aging.

CommScope pushes the boundaries of communications technology with game-changing ideas and ground-breaking discoveries that spark profound human achievement. We collaborate with our customers and partners to design, create and build the world's most advanced networks. It is our passion and commitment to identify the next opportunity and realize a better tomorrow.

COMMSCOPE®

commscope.com

Visit our website or contact your local CommScope representative for more information.

© 2024 CommScope, LLC. All rights reserved. CommScope and the CommScope logo are registered trademarks of CommScope and/or its affiliates in the U.S. and other countries. For additional trademark information see <https://www.commscope.com/trademarks>. All product names, trademarks and registered trademarks are property of their respective owners.

EB-112900.2-EN (04/24)